

KARAMI®

OUR NAME
SPELLS QUALITY

knowing your needs better

COLLECTION
2014



Reaching Out



KARAM Offices

Channel Partners

Dealer Partners

Retailer Partners

BANGALORE - Shop No.20/21, Ground Floor, SPA Plaza, OTC Road, Bangalore-560 002.
Phone: +91 80 41661080 / 90, Fax: +91 80 22220030, e-mail: bangalore@karam.in

DELHI NCR - D-95, Sector - 2, Noida-201301 Delhi NCR, India.
Phone: +91 120 4734400, Fax: +91 120 2541096, e-mail: delhi@karam.in

KOLKATA - Flat No.: L, 6th Floor, Block- I & II Diamond Chamber 4, Chowringhee Lane, Kolkata-700016.
Phone: +91 33 32476830, Fax: +91 33 22520181, e-mail: kolkata@karam.in

MUMBAI - The Affaires, Office No. 501, Plot No. 9, Sector-17, Palm Beach Road, Sanpada, Navi Mumbai-400705.
Phone: +91 22 27812390/ 64, Fax: +91 22 27812358, e-mail: mumbai@karam.in

Customer Care: Toll Free No. 1800 103 7085, e-mail- customercare@karam.in



It is our endeavor in KARAM to provide only the finest and the best solution in the field of personal protection to our valued customers. This time too, we introduce to you a wide range of products which have been produced after tireless hours of research and design, in response

to your constantly evolving needs.

Please do send us your valuable feedback on customercare@karam.in or call us on **Toll Free No. 1800 103 7085** and let us know how we can help you better.

GROWING & SHARING... **New** in 2014 by **KARAM**

	PAGE NO.
1 Revolta Harness - Oil / Dust / Water repellent range	6-8
2 No Spark Anti -Static Lanyards	9-11
3 Dienoc - Harnesses for Electrical Hazards	12
4 Flanil - Harness and Lanyards for Welding work at height	13-14
5 New light weight Sit Harnesses for Sports & Adventure	22
6 Vest Harnesses – for better visibility	28
7 Tools Lanyard – for protection from falling tools	33
8 Jaws & Jed -I Hooks – revolutionizing Connections	38-40
9 Internal Shock Absorbing Expandable Lanyards – Highest in the ergonomics & Safety	57-58
10 Point, Beam & Door Anchorages – providing a versatile tie - off solution	67-71
11 Telescopic Pole system – to create overhead anchorages at unreachable heights	72
12 Rope Grabs – in Stainless Steel and Aluminium – a wider option for you to choose from	75-82
13 Retractable Blocks – with additional features	99-100
14 Micron Retractable blocks – the lightest ever in its range	101
15 Retrieval Fall Arrestor Block – Serving as Block and a Winch – all in one	103
16 Komfy Kruz Ascend Descent Rescue Roll System	115-117
17 Evac and Evac-R – A compact device allowing Evacuation, Rescue and controlled descent	119-122
18 Seize'em Rescue Kit - Specifically designed for rescuing a suspended casualty	136
19 Shelblast - A sturdy & stylish Head Protection gear	140-141
20 Safety Spectacles - New Range added in existing range	161-163
21 Safety Footwear - Executive Safety Shoes & Occupational Shoes	188-192
22 Respiratory Protection Equipment - for protection against particulates, gasses & vapours.	193-198

Certification

Systems Certification (ISO:9001:2008)

Under this certification all processes and systems are stringently monitored to deliver quality product at each stage of manufacturing and service.

Product Certification (CE)

Nearly 100 products manufactured by KARAM are CE certified.

Our Certificates have been issued by Certifying Body SATRA-UK, in accordance with Article 10 of the PPE Directive 89/686/EEC. The Notified Body Number of SATRA is 0321.

Our on-going assessment body is SGS-UK which issues us our 11B certificate as per directive 89/686/EEC. The notified body number of SGS is 0120.

All our products are marked '0120'.

As per 11 B certificate all products marked CE 0120 must have a valid E.C. type examination certificate issued under Article 10.

SATRA

EC Type-Examination Certificate



EN 358	Belt for Work Positioning, Restraint & Work Positioning Lanyards
EN 361	Full Body Harnesses
EN 813	Sit Harnesses
EN 362	Hooks & Connectors
EN 354	Lanyards
EN 355	Energy Absorbers
EN 795	Anchorage Devices
EN 353-2	Guided type Fall Arrester including a Flexible Anchorage Line
EN 353-1	Guided type Fall Arrester including a Rigid Anchorage Line
EN 360	Retractable type Fall Arresters
EN 1496	Rescue Lifting Devices
EN 341	Descender Devices for Rescue
EN 1497	Rescue Harnesses
EN 397	Safety Helmet (Sheltek)
EN 166	Welding Shield & Spectacles
EN 175F	Helmet Attachable Welding Shield
EN 352-2	Ear Plugs
EN 352-1	Ear Muffs
EN 20345	Safety Shoes
IS 2925	Safety Helmet (Shelmet)
IS 3521	Full Body Harnesses (E-con Series)
IS 15298	Safety Shoes





Unit-I Producing Metal Hardware for Fall Protection - Lucknow (U.P.)



Unit-II Producing Soft Goods for Fall Protection - Lucknow (U.P.)

Since inception our motto is to make this planet a safer place to work in.

KARAM is a renowned name that spells & pronounces the Safety Story in a unique way. As a leading supplier to many Industries, KARAM has over the years earned a reputation in the World of Safety of **Trust and Reliability**.

KARAM specializes in the field of Fall Protection, Head Protection, Safety Shoes, Safety Spectacles, Hearing Protection, Welding Protection, Respiratory Protective Equipment and Rope-Access and Rescue.

In Short, KARAM is a one stop shop for personal protective equipment, providing solutions for protection from Head to Toe.

We manufacture the highest quality equipment conforming to **IS, DGMS, EN & ANSI** norms, leading the way with new innovative products and solutions with every passing year.

KARAM Manufacturing set-up is spread over a span of around 2,50,000 square feet area, and is the only one in the world with complete vertical integration, giving us strong controls over quality at each step of manufacturing. All our systems & processes are assessed by SGS U.K. & registered to ISO 9001-2008.

Along with an extensive Distribution network, KARAM has its offices all over the country, manned by Trained and Technical Sales Personnel to provide the finest support and service required.

Collection 2014 by KARAM brings forward the commitment made in the last edition, with newer additions of products in its ever expanding range, emerging today as a finest solution in the field of Industrial Safety.

The journey at KARAM is never ending. There is a long way to go, many more dreams to accomplish and we believe in joining hands with our valued customers for a Safer World.

Let's define Safety the KARAM way...



Unit-III Producing Helmets, Shoes, Fall Protection, Eye Protection, Ear Protection & Welding Protection - Sitarganj (Uttarakhand)



KARAM MANUFACTURING- FALL PROTECTION EQUIPMENT

KARAM is the only company in the world which has a vertically integrated manufacturing set up. Starting with yarn and processing it to make premium quality of Webbing and Rope, converting hot rolled coils, flats and extrusions of Steel and Aluminium Alloys into World class Fall Arrest Components.

Over the years KARAM has widened the scope of fall protection to suit workers of most industries including Telecommunications, Oil & Gas industry, Engineering industry, Power Transmission plants and Construction Industry.

Constant innovation and prime focus on research and design has enabled KARAM to provide Fall protection solutions to a worker working in some of the most hazardous industrial conditions.

Operations at KARAM are under constant vigilance to provide the finest in Quality of product and service.



Cold Stamping



Hydraulic Forming



Hot Forging

Heat Treatment



CNC Vertical Machining



Block Molding



Webbing Production





Kernmantle Rope Production



Twisted Rope Production



Assembly Line



Automatic Electro Galvanizing



Retractable Fall Arrester Assembly Line



Harness Stitching



Product Design & Development



Effluent Treatment Plant



KARAM MANUFACTURING- PERSONAL PROTECTION EQUIPMENT

KARAM has the finest and state of the art machinery to produce the best quality Head Protection, Eye Protection, Ear Protection, Welding Protection, Respiratory Protection and Foot Protection Gear.

Constant up-gradation of technology and focused attention towards providing the highest quality of product, has enabled KARAM to establish itself as a leading player in the field of PPE.

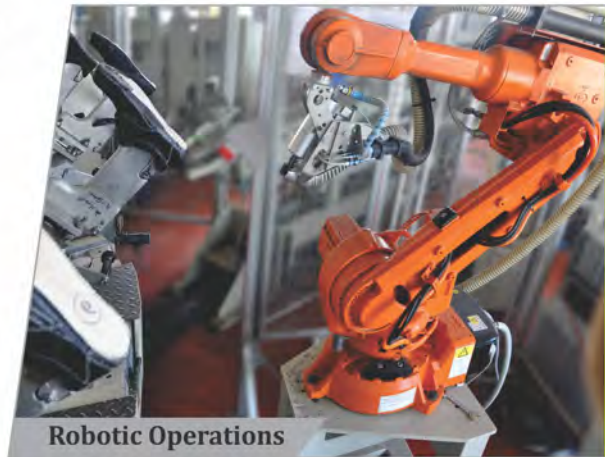

Robotic Operations



Safety Shoe Production



Automatic Shoes Stitching

Helmet Assembly Line



Helmet Moulding



Safety Spectacles Moulding



Ear Plug Production



“Testing Procedures”

Each and every step of manufacturing at KARAM follows adherence to strict quality parameters and focus lies on quality throughout the various stages involved. All raw as well as semi finished goods at KARAM also pass through stringent quality norms as laid down in the Quality Manual of the Company.

The final product, at KARAM is then tested to fulfill the requirements which are set much above the EN/ANSI Norms and ISI standards.

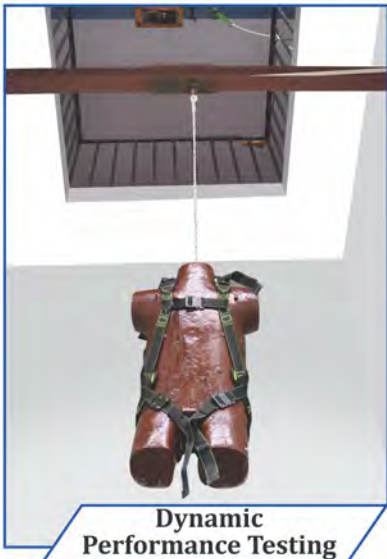

Dynamic Performance Testing

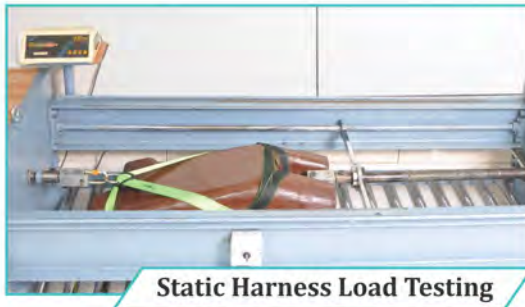

Static Harness Load Testing

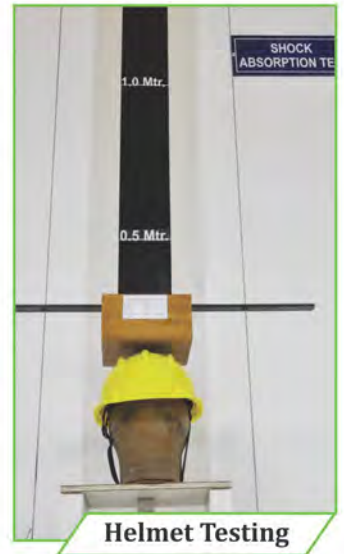

Helmet Testing



Shoe Testing



Proof Load Testing



Static Load Testing



Salt Spray Testing



Spectro Photo Meter Test



100% Visual Inspection



Chemical Analysis



Eyewear Testing

READY RECKONER

01



FULL BODY HARNESSSES

Work Positioning Belts/ Techno Series/ Magna Series/
Rhino Series / Elasto Series/ Vest Harnesses/ E-con Series

HOOKS & CONNECTORS

Jawz & Jed-1/ Steel Hooks & Connectors/
Anchorage Hooks/ Aluminium Hooks & Connectors



35

45



LANYARDS

Work Positioning Lanyards/ Restraint Lanyards/ Fall Arrest Lanyards/
Internal Shock Absorbing Lanyards/ Forked Lanyards/ Expandable Lanyards

ANCHORAGES

Webbing Slings/ Wire Rope Slings/ Anchors/ Door Anchor/
Telescopic Pole/ Temporary Horizontal Anchorage Line



61

75



ROPE GRAB FALL ARRESTER

FIXED LINE SYSTEMS

Vertical Anchorage Line System/ Horizontal Anchorage Line Systems



83

97



RETRACTABLE FALL ARRESTERS BLOCKS

CONFINED SPACE ENTRY



109

113



ROPE ACCESS & RESCUE

SELF CONTAINED SAFETY KIT



129



READY RECKONER

HEAD PROTECTION



137

151



SAFETY SPECTACLES

EAR PROTECTION



165

171



FOOT PROTECTION

RESPIRATORY PROTECTION



193

199



LOAD ARRESTERS

SAFETY NET

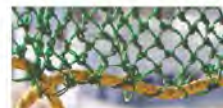

200

201



PPE INSPECTION

DISPOSAL METHOD FOR KARAM PRODUCT



202

203



KARAM TRAINING CENTER

KARAM AUTHORIZED SERVICE CENTER



204

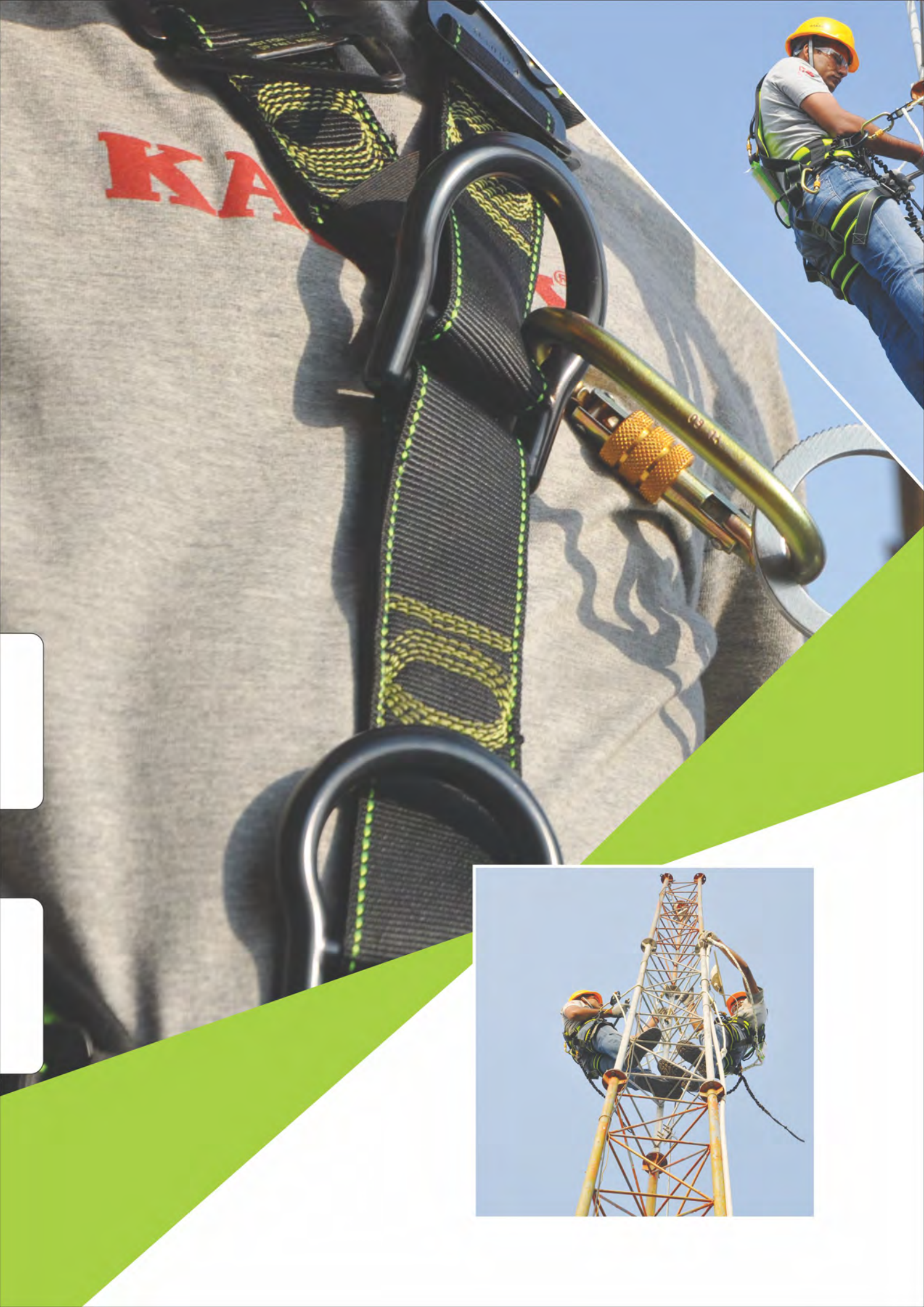

KA

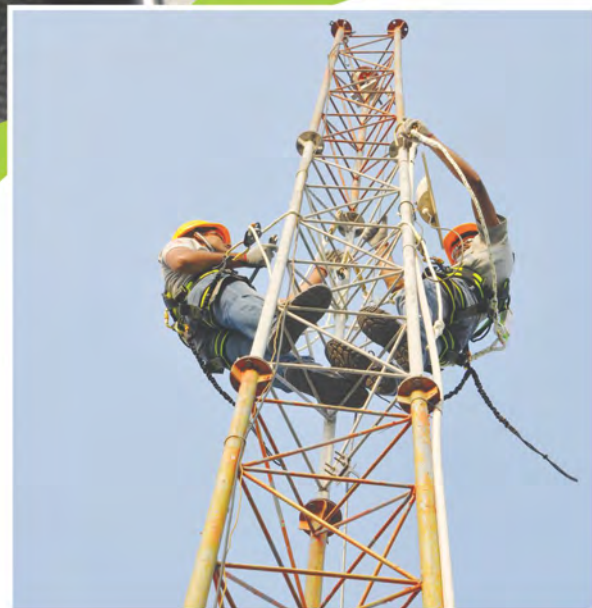



FALL PROTECTION

A Full Body Harness is the ideal body wear that should be worn by a worker, since it distributes the force of impact incurred in the event of a fall evenly on the thighs and torso region of the body.

The material of construction of the webbing of KARAM Harnesses is Polyester. Since this has the least elongation properties as compared to other materials, the Harness does not stretch dangerously when subjected to a fall. The wearer hence does not risk slipping out of the Harness.

KARAM offers a comprehensive range of Full Body Harnesses to suit a vast range of applications and situations.

Equipped with the finest ergonomics and technically sound features, KARAM Full Body Harnesses are the best choice for comfortable and safe usage for work at height.

Harnesses & Belts

Always inspect
the HARNESS
before WEARING it

Hold the Harness by the back D-ring, and allow the straps to fall in their place. The Harness has clear and separate colours for the shoulder and thigh straps, for them to be easily distinguished.

Inspect the Harness webbing for any cuts, burns or damages.

Check the stitches for their continuity.

Carefully look for any evidence of corrosion on the metal parts.

KARAM Harnesses also give an assurance that the Harness has not been subjected to a fall, if the unique Tell-Tale Indicator is still secure on the shoulder straps.



The Fall Indicator is a small label stitched to the back side of the shoulder strap and it flies out of the harness in the event of a fall, revealing a "DO NOT USE" sign.



Call **KARAM** Safety Expert
for further advise
Toll Free No.: 1800 103 7085



Attachment Points on the Harness:

The labels marked as 'A' denote the attachment points on the harness. In certain areas the labels are marked 'A/2' meaning that two similar points held together shall constitute a single attachment point.

KARAM ADVANTAGE

All KARAM Harnesses are made of Dope-Dyed high tenacity Polyester Yarn, imparting increased resistance to UV colour degradation.



HOW TO WEAR A HARNESS

The Harness can be worn following these simple steps-

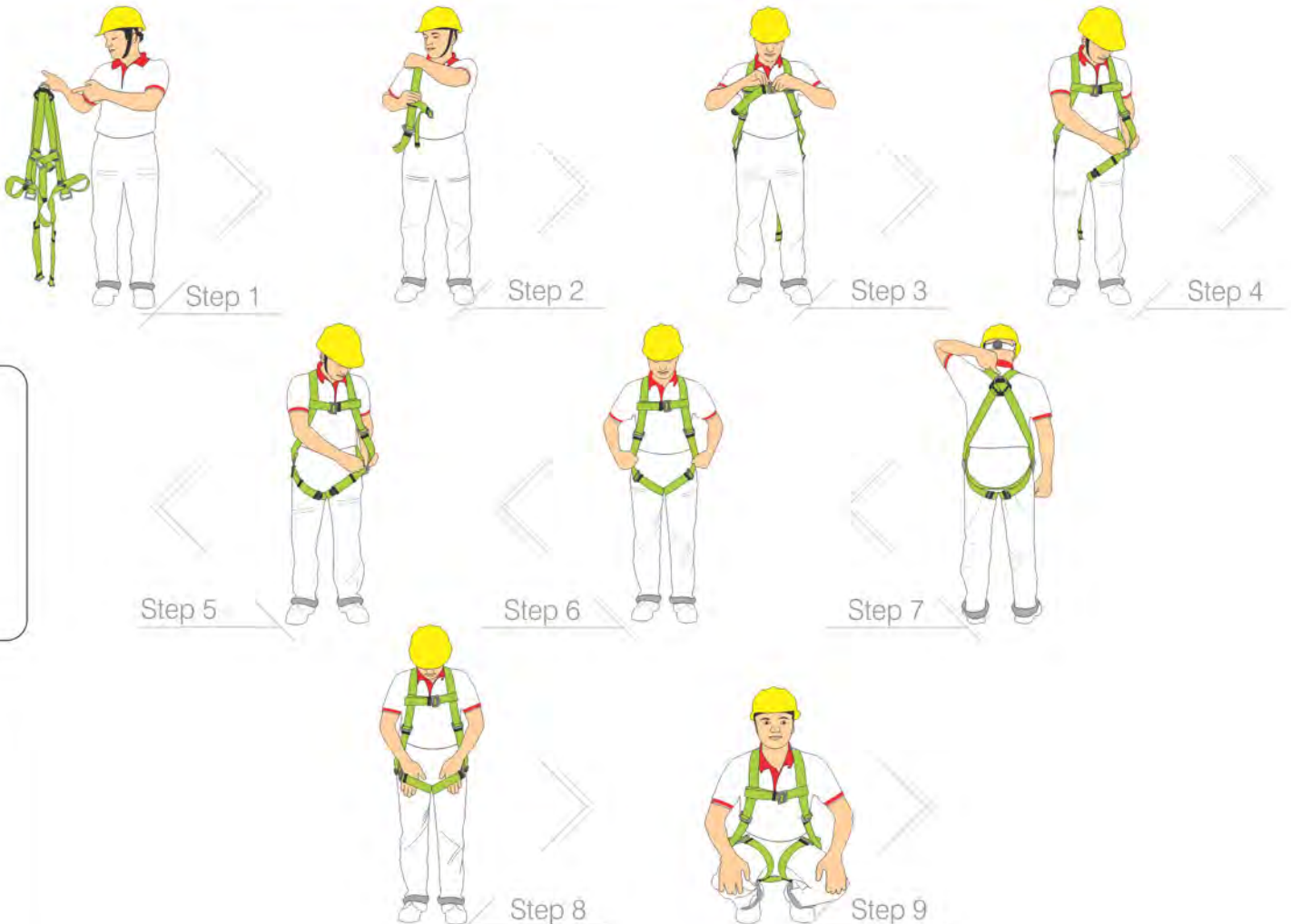



⚠ The Work Positioning Belts and Work Positioning Lanyards, should not be used for Fall Protection.

The Work Positioning System which comprises of a Work Positioning Belt along with a Work Positioning Lanyard enables the worker to work at heights in a well supported position, with both his hands free.

KARAM Work Positioning Belts have a sliding belt on the comfort pad, which enables the user to easily position the adjustment buckle of the belt at the center of his waist for smooth functioning.



**Wide Work Positioning Belt with Tool-holding loops
Ref. PN 01**

- ▶ Wide comfort pad to provide lumbar support for long working hours
- ▶ Fully Adjustable
- ▶ Width of Back Pad : 21 cms.
- ▶ Two Lateral D-Rings for Work Positioning
- ▶ Tool holding webbing loops
- ▶ Rings for tool holders, bolt bags, etc
- ▶ Available in sizes- Medium, Large, Extra Large
- ▶ Conforms to EN 358:1999



**Slim Work Positioning Belt with Tool-holding loops
Ref. PN 02**

- ▶ Optimum width comfort pad to provide sufficient lumbar support
- ▶ Fully Adjustable
- ▶ Width of Back Pad : 14.5 cms.
- ▶ Two Lateral D-Rings for Work Positioning
- ▶ Tool holding webbing loops
- ▶ Rings for tool holders, bolt bags, etc
- ▶ Available in sizes- Medium, Large, Extra Large
- ▶ Conforms to EN 358:1999



**Slim Work Positioning Belt
Ref. PN 03**

- ▶ Optimum width comfort pad to provide sufficient lumbar support
- ▶ Two Lateral D-Rings for Work Positioning
- ▶ Width of Back Pad : 14.5 cms.
- ▶ Rings for tool holders, bolt bags, etc
- ▶ Available in sizes- Medium, Large, Extra Large
- ▶ Conforms to EN 358:1999

Steps for Work Positioning

1

2

3

4

Adjust the lanyard length with the adjuster in order to work comfortably with both hands free.

KARAM[®]

7 TECHNO SERIES

KARAM

INTRODUCES

an entire RANGE of
TECHNO SERIES of HARNESSSES
and COMPATIBLE LANYARDS...



(A) **REVOLTA[™]**
SERIES

KARAM introduces REPEL technology webbing in their range of Harnesses, Lanyards and Pole strap which provides excellent resistance from build up of oil, dust, dirt and water.

(C) **Flanil[™]**

FLANIL range of KARAM Harnesses and Lanyards is made of special fibre which is flame resistant and specifically designed for workers engaged in welding and fire work at height.

(B) **NoSpark[™]**

KARAM offers its No SPARK range of Harnesses and Lanyards which are antistatic in nature hence do not create any sparking. This range offers the perfect solution for safe working at height in explosive atmospheres.

(D) **Dienoc[™]**

KARAM DIENOC Harnesses comes with high strength Die-Electric buckles & D-Rings made from specialized electrically insulating Polymers designed for the workers working in conditions where there are possible electrical hazards.



Call **KARAM** Safety Expert
for further advise
Toll Free No.: 1800 103 7085

KARAM®

INTRODUCES
REVOLTA™
SERIES



Repels
OIL, WATER & DUST

hence highly resistant to
Abrasion & Wear

KARAM introduces Revolta range of Harnesses and Lanyards specially designed for worker engaged in Petro chemical and Oil industry.

The specialized Webbing of the Revolta range is constructed from unique polyester webbing incorporating Repel Technology - a specialized coating which repels oil, dirt and water hence prevents their absorption on the webbing.

Ideal for use in:

A variety of applications including petrochemical, painting, water treatment, food processing, off shores and general industry.

Repel Technology
Persistent PERFORMANCE

 Oil Repellant	 Water Repellant	 Dust Repellant
--	--	---

Regular Webbing



Repel-Webbing of Revolta Harness



Significant Features:

- ▶ Oil and Dirt repellent webbing provides excellent resistance from build up of Oil and Dirt.
- ▶ Aluminum D-rings and Stainless Steel buckles/ Frames provides excellent corrosion resistance.
- ▶ Highly UV resistant.
- ▶ Deflects the dust, dirt or any unwanted material which causes abrasion hence is tear and cut resistant.
- ▶ Easy to care for, wipes clean in seconds.
- ▶ Increased durability and longevity.

TECHNO SERIES ↗



New



Revolta All Purpose Harness Ref. PN 56 (OR)

- ▶ Attachment Elements- 1 Dorsal and 1 Sternal D-Ring for Fall Arrest. 1 Ventral D-Ring at waist level for Rope Access work and 2 Lateral D-Rings for Work Positioning.
- ▶ Adaptability- Adjustable shoulder, thigh-straps and waist belt for extended comfort.
- ▶ Removable X-Back Pad for Shoulder Straps provides extreme comfort.
- ▶ Conforms to EN 361:2002, EN 358:1999 & EN 813:2008.

REVOLTA SERIES

KARAM offers a range of REVOLTA Harnesses and Lanyards to suit various applications, right from Climbing, Work Positioning, Rope Access and Rescue.

KARAM also offers ANSI Certified REVOLTA Forked Internal Shock Absorbing Lanyards

New

Revolta Positioning Harness Ref. PN 44 (OR)

- ▶ Attachment Elements- One chest attachment D-ring and a Dorsal attachment D-ring for Fall Arrest. Two lateral attachment D-rings for work positioning.
- ▶ Adaptability- Adjustable shoulder and thigh-straps.
- ▶ Soft Padded Work positioning belt gives extreme working comfort and safety.
- ▶ Conforms to EN 361:2002 & EN 358:1999.



New



Revolta Climbers Harness Ref. PN 24 (OR)

- ▶ Attachment Elements- 1 Chest attachment D- Ring and a Dorsal attachment D-Ring for Fall Arrest.
- ▶ Adaptability- Adjustable shoulder and thigh-straps.
- ▶ Conforms to EN 361:2002.



Call **KARAM** Safety Expert
for further advise
Toll Free No.: 1800 103 7085

Dorsal ● Sternal ● Lateral ● Belt ■ Ventral ●



Revolta Fall Arrest Lanyard
Ref. PN 399 (IS) (A) (OR)

- ▶ Specifications : Expandable Single leg Fall Arrest lanyard. Elastic in nature and prevents tripping over the lanyard.
- ▶ Available Length : 1.5m (Relaxed Length), 2.0m (Expanded Length)
- ▶ Attachment Elements : Aluminium Rebar Hook PN 136 at one end & Aluminum Snap Hook PN 129 at other end.
- ▶ Conforms to : EN 355:2002 & EN 354:2010.



Revolta Pole Strap
Ref. PN 248 (OR)

- ▶ Specifications : Made from 44mm wide oil repellent webbing incorporated with 44mm tubular webbing for abrasion resistant.
- ▶ Available Length : Adjustable upto 2.0m
- ▶ Attachment Elements : Incorporated with Aluminium Snap Hooks 129 at both the ends for excellent corrosion resistance.
- ▶ Conforms to : EN 358:1999

The ANSI certified KARAM REVOLTA Forked Lanyards have the unique repellent technology along with internal shock absorption. They are provided with different configurations of Hooks to suit various applications.



Revolta Forked Fall Arrest Lanyard
Ref. FAP 30398 (6) (OR)

Specifications	Available Length	Attachment Elements	Conforms to
Elasticated Lanyard Incorporated with 6 ft free fall Shock Absorption	4.5ft (Relaxed Length)	Steel Stamped Snap Hook PN 146 at all three ends.	ANSI Z 359.13-2009
Breaking Strength of Webbing: 6000lbs	6.0ft (Expanded Length)		



Revolta Forked Fall Arrest Lanyard with Rebar Hook
Ref. FAP 30399 (6) (OR)

Specifications	Available Length	Attachment Elements	Conforms to
Elasticated Lanyard Incorporated with 6 ft free fall Shock Absorption	4.5ft (Relaxed Length)	Steel Stamped Snap Hook PN 146 at attachment end and two Steel Stamped Rebar Hooks PN 149 at Anchorage ends.	ANSI Z 359.13-2009
Breaking Strength of Webbing: 6000lbs	6.0ft (Expanded Length)		

KARAM®

INTRODUCES

No Spark

Range of Harnesses and Lanyards

The revolutionary NO SPARK Range of Harnesses & Lanyards introduced by KARAM are antistatic in nature and are ATEX Certified.

They have been designed to offer the perfect solution for safe working at height in potentially explosive atmosphere.



Adjustable Shoulder Straps

Stainless Steel Buckles for excellent Corrosion Protection



Webbing made of Antistatic Material prevents the risk of build up of charge

Forged Aluminium Dorsal D-ring for Fall Arrest

Front attachment textile loops for Fall Arrest

Adjustable Thigh Straps



II 2 G c T6

Ref. PN 22 (AS)

ATEX 94/9/CE EN 1149-1:2006 & EN 1149-5:2008

Conforms to EN 361: Fall Arrest Harness.

Harness webbing also tested for surface resistance as per EN 1149-1:2006 & EN 1149-5:2008



Call **KARAM** Safety Expert for further advise
Toll Free No.: 1800 103 7085



KARAM introduces NO SPARK Single and Forked Fall Arrest Lanyards for safe working at height. In conjunction with NO SPARK Harness, the usage of these Lanyards completes a safe ANTISTATIC fall protection gear during work at height in hazardous conditions.

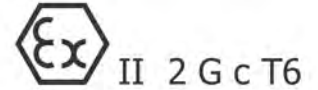

No Spark Antistatic E.A. Lanyard
Ref. PN 361 (AS)

No Spark Antistatic E.A. Lanyard
Ref. PN 328 (AS)

Ref.	Material	Available Lengths	Attachment Elements	Conforms to
PN 361 (AS)	44mm wide Antistatic webbing	1.5m, 1.8m & 2.0m	Aluminium Karabiner PN 117 with Energy Absorber PN 300(AS) at one end and Aluminium Rebar Hook PN 136 at other ends.	Atex 94/9/CE, EN 13463-1:2009 and EN 13463-5:2003. Lanyards webbing also tested for surface resistance as per EN 1149-1:2006 and EN 1149-5:2008.
PN 328 (AS)	44mm wide Antistatic webbing	1.0m, 1.5m, 1.8m & 2.0m	Aluminium Karabiner PN 117 with Energy Absorber PN 300(AS) at one end and Aluminium Rebar Hook PN 136 at other end.	

Why No Spark

A unique challenge while working at height is faced in those areas which have an explosive atmosphere. Besides height, the other big hazard is the presence of volatile compounds in the air. This air can suddenly burst into flames in the event of generation of spark. Products made of polymer and plastics are susceptible to create sparking because they tend to accumulate charge on them. Thus all regular Harnesses, made of polyester or similar polymers have a tendency to accumulate charge on them which leads to spark generation.

KARAM 'NO SPARK' range of harnesses and lanyards are specially constructed so as to not to collect this charge on them, hence not to create any sparking



Regular Webbing
Spark results from static charge build up on the harness and its sudden discharge.



KARAM Specialized Webbing
NO SPARK webbing of KARAM Harnesses does not allow any charge to build up, hence does not cause any sparking.

Anti Static NO SPARK webbing also does not allow dust particles to accumulate



Regular Webbing
Normal webbing attracts dust due to build up of charge.



KARAM Specialized Webbing
The special Antistatic No Spark range of KARAM harnesses do not allow dust and micro dirt particles to collect over them since the specialized webbing used does not allow any charge to develop on it.



All metal components on the 'NO SPARK' range of Harnesses are made up of Stainless Steel which is an excellent conductor of electricity, hence prevents any build up of charge.

Antistatic 'No spark' range of KARAM Harnesses & Lanyard should be used in explosive work environment for providing complete and fool proof protection of working at height without facing additional hazard of fire due to sparking. No Spark range of products are also an ideal choice for use during work at height in the industries which require a contaminant-free and dust free environment.



Oil and Gas



Petrochemical Plants



Filling Stations



Mining Industry



Pharmaceutical Industry



Electronic Industry



Medical & Surgical Industry

The No Spark Range of KARAM products are ATEX certified by SIRA.

ATEX certification involves a detailed process of examination, testing and assessment of the equipment intended to be used in potentially hazardous areas, with the end result being the issue of ATEX certificate and report, confirming that the product is safe to use within potentially explosive atmosphere.

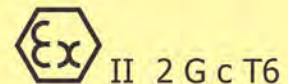

The No Spark harnesses and lanyards are also CE certified as per relevant EN Norms.

Other KARAM products which are ATEX certified, and may be used to create a complete and compatible 'Antistatic' personal protective fall protection cover for the user:-

Ref.	Product	Page No.
PN 22 (AS)	No Spark Antistatic Harness	09
PN 328 (AS)	No Spark Antistatic E.A Lanyard	10
PN 361 (AS)	No Spark Antistatic E.A Forked Lanyard	91-94
PN 4000	Horizontal Anchorage Line System on Rigid Cable Line	106
PN 116	Aluminium Screw - Locking Karabiner	107
PCGS 7.5	Retractable Block Polymer Casing with G.I Wire Rope	
PCGS 15	Retractable Block Polymer Casing with G.I Wire Rope	



CE
EN 1149-1:2006
EN 1149-5:2008

The Dienoc range of harnesses have been specially designed for workers working in conditions where there are possible electrical hazards. Special Dielectric D-Rings, buckles and frames used in this range of harnesses are completely electrically insulated.

Harness for ELECTRICAL HAZARDS in TRANSMISSION INDUSTRY

KARAM DIENOC Harnesses come with high strength Dielectric Buckles & D-rings constructed from specialized Electrically Insulating Polymers

New



Dienoc Dielectric Non-Conductive Harness Ref. PN 22(DE)

- ▶ Consists of two chest attachment textile loops and a Non-Conductive Dorsal attachment D-ring for Fall Arrest.
- ▶ **Shoulder straps are elasticated to provide flexibility and snug fitting to the user.**
- ▶ Use of special plastic coated D-Rings and all metal adjustment buckles makes it completely electrically insulated.
- ▶ Conforms to EN 361:2002.



Ref. PN 42(DE)

- ▶ Consists of two chest attachment textile loops and a Non-Conductive Dorsal attachment D-ring for Fall Arrest.
- ▶ Two Non-Conductive lateral D-Rings at waist level for Work Positioning
- ▶ **Shoulder straps are elasticated to provide flexibility and snug fitting to the user.**
- ▶ Use of special plastic coated D-Rings and all metal adjustment buckles makes it completely electrically insulated.
- ▶ Conforms to EN 361:2002 and EN 358:1999.

Flanil™

TECHNO SERIES

The Flanil Range of KARAM Harnesses & Lanyards have been specially designed for workers engaged in Welding and Hot work at height.

The Webbing of the Flanil Harness & Lanyards is made of a special fibre which is Flame Resistant and can withstand temperatures of upto 700°F/371°C with out any damage.

Use for WELDING WORK at Height

Now the Spark will not compromise the strength of your Fall Protection Gear!



Call **KARAM** Safety Expert for further advise
Toll Free No.: 1800 103 7085

Flanil Flame Resistant Full body Harness Ref. PN 22(FR)

- ▶ The Harness is provided with adjustable Chest, Shoulder & Thigh straps. Also comes with two front attachment textile loops in addition to the Dorsal D-ring for fall Arrest.
- ▶ This harness conforms to EN 361: 2002 The Webbing is also tested in accordance with ISO 15025 : 2002 and assessed in accordance with ISO 9150 : 1988.



Flanil Flame Resistant Full Body Harness Ref. PN 42 (02) (FR)

- ▶ The Harness is provided with adjustable Chest, Shoulder & Thigh straps. Also comes with two front attachment textile loops in addition to the Dorsal D-ring for fall Arrest.
- ▶ 2 lateral D-Rings at waist level on the sides for Work Positioning.
- ▶ Soft Padding on Waist for extended comfort. Ideally positioned Sit-strap for long lasting comfort.
- ▶ Conforms to EN 358:1999, EN 361:2002, ISO 9150:1988 & ISO 15025:2002.



KARAM 'FLANIL' webbing withstands exposure to welding sparks hence maintains its strength.

Normal webbing gets damaged and weakened on exposure to welding sparks.



KARAM also offers **FLAME RESISTANT LANYARDS** which are compatible with Flanil Flame Resistant **FULL BODY HARNESSSES** to ensure complete protection to the workers engaged in welding & hot work at height.



Ref. PN 371 (FR)
Flanil Expandable Fall Arrest Forked Lanyard



Ref. PN 261 (FR)
Flanil Restraint Forked Lanyard



Ref. PN 361 (FR)
Flanil Fall Arrest Forked Lanyard



Ref. PN 804 (FR)
Flanil Anchorage Sling



Ref. PN 328 (FR)
Flanil Fall Arrest Single Lanyard



Ref. PN 243 (FR)
Flanil Work Positioning Lanyard

Ref.	Use	Material	Length	Attachment Elements	Conforms to
PN 371(FR)	For Fall Arrest	44mm wide Flame Resistant Elasticated Webbing	Expanded Length : 2.mtrs. Relaxed Length : 1.4 mtrs.	One side Karabiner (PN 112) & two Steel Scaffold Hooks PN 131 at other ends.	EN 355:2002 + VG 11/ PFE 63 (Additional Static Strength Test) ISO 9150 : 1988 & ISO 15025 : 2002.
PN 261 (FR)	For Restraint	44mm wide Flame Resistant Webbing	Available in: 1.0m, 1.5m, 2.0m.	Consists of Karabiner (PN 112) at one end and 2 Steel Scaffold Hooks (PN 131) at other ends.	EN 354:2010, ISO 9150:1988 & ISO 15025:2002.
PN 328 (FR)	For Fall Arrest	44mm wide Flame Resistant Webbing	Available in: 1.5m, 2.0m.	Karabiner (PN 112) with Energy Absorber at one end & Steel Scaffold Hook (PN 131) at other end.	EN 355:2002, ISO 9150:1988 & ISO 15025:2002.
PN 361 (FR)	For Fall Arrest	44mm wide Flame Resistant Webbing	Available in: 1.0m, 1.5m, 2.0m.	Karabiner (PN 112) at one end & two Steel Scaffold Hooks (PN 131) at other ends.	EN 355:2002 and tested as per VG11 of PPE Directive 89/686/EEC, ISO 9150:1988 & ISO 15025:2002.
PN 804 (FR)	For Anchorage	44mm wide Flame Resistant Webbing	Available in: 1.0m, 1.5m, 2.0m.	Equipped with steel D-Rings at both the ends.	EN 795:2012 Class B, ISO 9150:1988 & ISO 15025:2002. (Breaking Strength Min. : 15kN)
PN 243 (FR)	For Work Positioning	33mm wide Flame Resistant Webbing	Ring Adjuster allows Length Adjustment to Maximum : 2.0m.	Provided with Screw Locking Karabiner PN 112 at both the ends for attachment.	EN 358:1999, ISO 9150:1988 and ISO 15025 : 2002



KARAM®

OFFERS

a wide RANGE of REGULAR
HARNESSES to combat the
dangers of fall from HEIGHT...

(A) **MAGNA™**
HARNESSES

KARAM All-purpose Magna range of Full Body Harnesses offers high level of ergonomics. Equipped with Light Weight Aluminium D-rings, Quick Connect Automatic Buckles and tangle free design that facilitates maximum comfort at all times.

(B) **RHINO™**

As the name speaks itself, the Rhino range of harnesses are sturdy and withstand the highest test of safety standards laid out in the European Norm and are CE certified. Rhino Harnesses are equipped with unique features that provide full comfort and safety to the wearer.

(C) **ELASTO™**

KARAM Elasto Full Body Harnesses are made of elastic webbing, providing comfort, versatility, and safety. The Harness is designed for easy fitting and the elastic nature of these harnesses enable the user to work with more freedom.



(D) **VEST-HARNESSES™**

KARAM introduces Vest Harnesses especially designed into the vest for tangle free body wear. Incorporated with multiple pockets and retro reflective tape, these Harnesses are good for use in workshops, maintenance, service and many other applications.

(E) **E-CON™**
SERIES

E-Con Full Body Harnesses take consideration of safety and compliance. They are made up of new advanced Polyester webbing and are equipped with easy to use buckles, and are IS Certified.



Call **KARAM** Safety Expert
for further advise
Toll Free No.: 1800 103 7085



MAGNATM
HARNESSES

Magna is the Premium Series of KARAM Harnesses and comes with the highest features of Ergonomics, Comfort and Safety, Quick Connect Automatic Buckles, and a Tangle-Free Design.

Now Lighter than ever before, having Aluminium D-rings!



New Wrap Around Velcro Fastened Label Cover to secure all product information under it.



ID Plate: Dorsal Webbing Holding Cross Plate maintains the D-ring in place even after a fall.

Elastic Loops: Specially designed to retain the excess strap while adjustment.



Automatic Buckles: Extremely easy to use for single-hand adjustment.

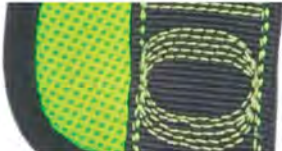

Stitching Pattern: Unique aesthetic stitch pattern for enhanced stitching, strength and smartstyling.

Combination Buckles: With a unique pull-up grip, these buckles are very easy to use & can be tightened/ loosened with one hand. They provide for very comfortable adjustment, keeping the Harness snug fit to the body.



Thigh Straps: The distinctively placed fully padded straps with automatic buckles allow easy adjustment. The knitted mesh net used in the pads maintains proper air circulation.

Distinctive FEATURES of **KARAM** MAGNA RANGE

Shoulder Straps: Fully padded Shoulder straps with knitted mesh pads for better comfort and air circulation.



Lanyard Keepers: Specially designed keepers on both sides for safely attaching the free connector end of forked lanyard.

Metal Components: All hardware used are Black Powder Coated to provide the highest degree of corrosion resistance packed with high aesthetic appeal.



Work Positioning Belt: With knitted mesh pads for extra comfort. The belt is provided with holding loops for attaching tool bags etc.



Lateral D-Rings: Specially designed to stand out, enabling easy attachment to the work positioning Lanyard.

Certified and Conforms to EN 361 : 2002, EN 358 : 1999 & EN 813 : 2008



- ♦ Equipped with light Weight Aluminium D-Rings to facilitate maximum comfort.
- ♦ D-Ring with "BEND" for easy accessibility to the user during positioning at all times.

MAGNA

HARNESSES

Now Lighter than ever before, having Aluminium D-rings!

LONG WORKING HOURS at height makes your **BODY ACHE** and **EXHAUSTED**

We have a **SOLUTION** for **YOUR PROBLEM...**
 "Use **EXTREMELY COMFORTABLE MAGNA HARNESSES**, Specially Design for protection during **EXTENDED HOURS** at **HEIGHT**"



Ref. MAGNA 1

Magna 1 Harness has a single dorsal attachment D-ring, and two front attachment textile loops for fall arrest. It is designed for use for fall protection during extended hours of working at height.



Ref. MAGNA 2

Magna 2 Harness is one of the most extensively used harnesses of KARAM, particularly for **Tower and Ladder Climbing**. The sternal attachment textile loops can be attached to a rope-grab to allow safe anchorage while climbing. The two lateral D-rings on this harness provide attachment for **Work-Positioning** lanyards, enabling safe and comfortable positioning at a height. **The lumbar mesh-pad provides extreme level of support to the back while working at a height.**



Ref. No.	Material	Standard	Application	Attachment Point				Weight	Adjustability
				Dorsal D	Sternal Q	Lateral OO	Ventral Q		
Magna 1	Polyester	EN 361:2002	FA	✓	✓			1680 gms	Fully adjustable shoulder, chest strap & thigh straps.
Magna 2	Polyester	EN 361:2002 EN 358:1999	FA + WP	✓	✓	✓		2210 gms	Adjustable shoulder, thigh-straps and waist belt.

* FA = Fall Arrest; WP = Work Positioning

Dorsal ● Sternal ● Lateral ● Belt ■ Ventral ●

Now Lighter than ever before, having Aluminium D-rings!



Call **KARAM** Safety Expert for further advise
Toll Free No.: 1800 103 7085

Need all in One..... **COMFORT** **ADJUSTABILITY** and **ERGONOMICS**

KARAM UNDERSTANDS your needs & offers you **MAGNA** **ALL PURPOSE HARNESSES** for all your **EXTREME** **WORK SITUATIONS**

New



Ref. MAGNA 2(W)

Magna 2(W) Harness is specifically designed for the windmill industry. It is equipped with one Sternal D-Ring for fall arrest and two Lateral D-Rings for Work Positioning. It has a back cover with velcro on waist belt for lumbar support. The grommeted waist belt allows easy adjustment. **Can also be provided with Suspension Intolerance Straps to combat the ill effects of Suspension Trauma.**



All Purpose Harness

Ref. MAGNA 3

Equipped with the all features of Adjustability & Ergonomics, **KARAM Magna 3** is an ideal Harness for Fall Arrest and Work Positioning while working for long hours at a height.

However, it is the ventral and sternal attachment D-rings on this harness that makes it the right choice for use in Rescue, Rope Access, Tower Climbing and Window Cleaning.



Ref. No.	Material	Standard	Application	Attachment Point				Weight	Adjustability
				Dorsal 	Sternal 	Lateral 	Ventral 		
Magna 2 (W)	Polyester	EN 361:2002 EN 358:1999	FA + WP	✓	✓	✓		2600 gms	Adjustable shoulder, thigh-straps and waist belt.
Magna 3	Polyester	EN 361:2002 EN 358:1999 EN 813:2008	FA + WP + RA	✓	✓	✓	✓	2410 gms	Adjustable shoulder, thigh-straps and waist belt.

* FA = Fall Arrest; WP = Work Positioning; RA = Rope Access

Dorsal ● Sternal ● Lateral ● Belt ■ Ventral ●



FULL BODY HARNESSSES

KARAM Rhino Range of Full Body Harnesses comes in the catchy combination of Green and Black.

Equipped with unique features that provide full comfort and ergonomics to the wearer, this range of Harnesses withstands the highest test of Safety standards as laid out in the European Norms, and is CE Certified.

FEATURES of KARAM® RHINO RANGE

Web Keepers : All End Straps equipped with unique plastic web keepers for **minimizing the chances of accidental openings** of web ends, hence ensure that the Harness is snugly fit at all times. Also, it gives better grip while adjustment.

Label : All labels and markings of the harness are enclosed within **strong polyethylene tube** to prevent the fading of print due to sunlight and water, thereby ensuring that the marking stays longer.

Adjustment Buckles: All adjustment buckles are provided with a unique **"Pull Grip"** to **enable easy pull down** with thumb and easy to adjust straps for a good fit.

Marking A or A/2 (two together): Denotes attachment point for Fall Arrest.

Fluorescent green colour of the webbing is **conspicuous** and makes it easier for safety officers to locate workers.



Dorsal Attachment Point: For attachment to Fall Arrest, enables straight upright position in the event of a fall.

Chest Strap: In most of the models the chest strap is equipped with unique **sliding chest strap plates** to enable the user to bring chest strap in required position.

All metal fittings come with yellow passivation which offers better corrosion resistance, capable of taking salt spray test of minimum 72 hours against 50 hours requirement as per the EN Norms.



All textile loops of the harness covered with strong textile reinforcement to reduce abrasion of the webbing when in contact with the metallic connectors.



Option of captive pin on request

KARAM offers the Harnesses that comes with the Screw-Locking Karabiner PN 112(C) (With captive pin), permanently attached to the dorsal D-ring of the Harness. **A damaged Lanyard can be easily removed from the Dorsal-Ding and replaced by a fresh one when using such a Karabiner.** This range is available on all the KARAM Harness models and are referred to as Model RefNo. with 'K' eg : PN 12(K), PN 22(K) etc.



Now
**DISENGAGE
YOURSELF EASILY**
at the time of
EMERGENCY!

Extension Band

Allows easy Reach
to your Harness
Dorsal D-ring

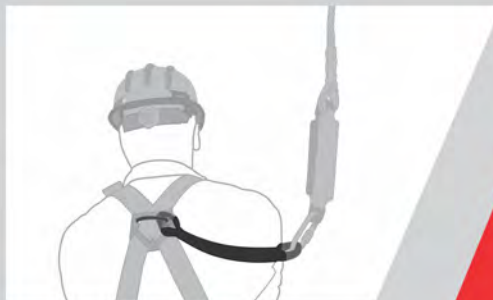

This Extension Band allows the user to easily connect to or disengage from himself the dorsal attachment D-Ring without any external help.



IMPORTANT - It is advisable to use a lanyard of length less than 1.5m if an Extension Band equipped Harness is used.



This Unique Optional Extension Band (made of 30cm Length webbing) on the Dorsal Attachment D-Ring is provided on request on all models of KARAM Harnesses



Is **WORKING** on a **TOWER**.....
the **NEED** of the **HOUR**

KARAM offers **TOWER HARNESSES** Designed for the **PROFESSIONAL INVOLVED IN CLIMBING, ROPE ACCESS & RESCUE.**



Ref. PN 57

PN 57 is a Tower Harness which can be easily donned by simply pulling up the shoulder straps and connecting them with the ventral chest strap using a Karabiner.



Ref. PN 56

PN 56 is a special Tower Harness in the KARAM Rhino Range. Equipped with comfortable padding on shoulder, waist and the thigh pads, PN 56 is a comfortable Harness and very versatile in its use. The Dorsal, Ventral, Sternal and Lateral attachment points on this Harness allow it to be used for fall arrest by Dorsal attachment, fall arrest by front attachment, work positioning, and for rope access. **It is the most popular Harness used for the purpose of carrying out Rescue of a fall victim, by descent.**



Use Karabiner with Captive Pin (page 19). Use Extension Band for easy reach to Dorsal D-ring (page 20)

Ref. No.	Material	Standard	Application	Attachment Point				Weight	Adjustability
				Dorsal 	Sternal 	Lateral 	Ventral 		
PN 57	Polyester	EN 361:2002 EN 358:1999 EN 813:2008	FA+WP+RA	✓	✓	✓	✓	2440 gms	Fully adjustable shoulder & thigh straps.
PN 56	Polyester	EN 361:2002 EN 358:1999 EN 813:2008	FA+WP+RA	✓	✓	✓	✓	2000 gms	Fully adjustable shoulder & thigh straps.

* FA = Fall Arrest; WP = Work Positioning; RA = Rope Access

Dorsal ● Sternal ● Lateral ● Belt ■ Ventral ●



LIGHT WEIGHT SIT HARNESS For SPORTS and ADVENTURE

KARAM offers Adventure Sit Harness - PN 51 the Light and Zippy Harness Specially designed keeping in mind the needs of Mountaineers and Adventure Geeks.



Adventure Sit Harness Ref. PN 51 (A)

- ▶ This Harness is used by mountaineers, tree-climbers and loggers, for positioning and rope access.
- ▶ This Harness is equipped with light weight Aluminum D-Rings.
- ▶ Consists of two lateral D-rings for Work positioning and Ventral D-ring for Rope access.
- ▶ Adjustable Thigh Straps & Waist Belt.
- ▶ With wide and semi-rigid waste belt for excellent support.
- ▶ The waist belt and the leg straps are provided with a soft padding that provide best possible comfort to the wearer.
- ▶ The rear attachment point on the waist belt allows connection of a restraint lanyard facilitating it to be used by personnel's for tree climbing, logging and for rope access.
- ▶ The two lateral attachment points equally distributes the weight around the waist belt for comfort when leaning back.
- ▶ For comfort, the ventral attachment distributes the weight evenly between the waist belt and the leg loops during suspension work.
- ▶ Conforms to EN 358:1999 & EN 813:2008.



Call **KARAM** Safety Expert
for further advise
Toll Free No.: 1800 103 7085

KARAM PN 51 (A) is a Sit Harness, and is not a Harness for fall protection.

OTHER MOUNTAINEERING PRODUCT OFFERED BY KARAM

Ref. No.	Product Name	Ref. No.	Product Name
PN 401	Grip Desender	PN 127	Aluminium Quarter Turn-locking Snap Hook
PN 950(K)	Kernmantle Rope Anchorage Line	PN 128	Aluminium Triple Action locking Snap Hook
PN 116F	Aluminium Screw-locking Karabiner (Forged)	PN 803	Anchorage Webbing Sling
PN 117F	Aluminium Quarter Turn-locking Karabiner (Forged)	PN 2000B	Fall Arrester on Polyamide Rope
PN 118F	Aluminium Triple Action locking Karabiner (Forged)	PN 950	Twisted Rope Anchorage Line
PN 126	Aluminium Screw-locking Hook		



Is **COMFORT** and **RESCUE** YOUR **DEMAND** ?

YES! We Understand your **DEMAND** & offer you a perfect Combo of **COMFORT & RESCUE** at all **TIMES**



Ref. PN 45(01)
PN 45(02)
PN 45(03)

The Suspension Strap incorporated on the shoulder strap of the Harness Ref. PN 45 has a D-Ring which can be used to connect to the Rescue Equipment, when in need. **It is not to be used for suspension but for retrieval.** The Suspension Strap otherwise lies attached to the shoulder strap with the Velcro binding, when not in use.

Ref. PN 44(01)
PN 44(02)
PN 44(03)

PN 44 is an ideal Harness equipped with one chest attachment D-ring & Dorsal D-ring for fall arrest. Two lateral rings for work positioning. **Is best suited for Tower Climbing & Work Positioning at height.**

Use Karabiner with Captive Pin (page 19). Use Extension Band for easy reach to Dorsal D-ring (page 20)

Ref. No.	Material	Standard	Application	Attachment Point					Rescue Strap	Weight	Adjustability
				Dorsal	Sternal	Lateral	Ventral				
PN 45	Polyester	EN 361:2002 EN 358:1999 EN 1497:2007	FA+WP+R	✓	✓	✓		✓	1900 gms	Adjustable shoulder, thigh-straps.	
PN 44	Polyester	EN 361:2002 EN 358:1999	FA+WP	✓	✓	✓			1800 gms	Adjustable shoulder, thigh-straps.	



LOOKING for the IDEAL TOWER HARNESS ?

KARAM offers you a range of TOWER HARNESSES PN 43, PN 42. Choose the Waist-belt from wide padded belt with tool-loops (PN 01) to slimmer pad with tool loops (PN 02) or a simple slim pad (PN 03).



Ref. PN 43(01)
PN 43(02)
PN 43(03)

Equipped with 2 chest attachment D-rings and all the adjustability features, PN 43 is the ideal Harness for Tower Climbing, Work Positioning and Working on Mast.



Ref. PN 42(01)
PN 42(02)
PN 42(03)

Consists of front Attachment textile loops, this Harness is the best Harness for tower climbing and work positioning at height.

Use Karabiner with Captive Pin (page 19). Use Extension Band for easy reach to Dorsal D-ring (page 20)

Ref. No.	Material	Standard	Application	Attachment Point				Weight	Adjustability
				Dorsal ☐	Sternal ☐	Lateral ☐☐	Ventral ☐		
PN 43	Polyester	EN 361:2002 EN 358:1999	FA+WP	✓	✓	✓		1780 gms	Adjustable shoulder, thigh-straps and waist belt.
PN 42	Polyester	EN 361:2002 EN 358:1999	FA+WP	✓	✓	✓		1780 gms	Adjustable shoulder, thigh-straps and waist belt.



Easy to **DON** and **DOFF** with **SIT STRAP** for **EXTENDED** comfort while **WORKING** at **HEIGHT**



Call **KARAM** Safety Expert for further advise
Toll Free No.: 1800 103 7085



Ref. PN 41(01)
PN 41(02)
PN 41(03)

Having all the adjustability features KARAM PN 41 is a specialized Harness for Work Positioning at height in Industries like Chemicals & Fertilizers.



Ref. PN 23

Has Two Chest Attachment D-ring, Adjustable Shoulders and Thigh Strap with sliding plates for easy attachment of chest strap.



Ref. PN 22

Has Two Chest Attachment Textile loops with adjustable shoulder and thigh strap.



Use Karabiner with Captive Pin (page 19). Use Extension Band for easy reach to Dorsal D-ring (page 20)

Ref. No.	Material	Standard	Application	Attachment Point				Weight	Adjustability
				Dorsal 	Sternal 	Lateral 	Ventral 		
PN 41	Polyester	EN 361:2002 EN 358:1999	WP+RA	✓		✓		1720 gms	Adjustable shoulder, thigh-straps and waist belt.
PN 23	Polyester	EN 361:2002	FA	✓	✓			1300 gms	Adjustable shoulder & thigh-straps.
PN 22	Polyester	EN 361:2002	FA	✓	✓			1200 gms	Adjustable shoulder & thigh-straps.

* FA = Fall Arrest; WP = Work Positioning; RA = Rope Access

Dorsal ● Sternal ● Lateral ● Belt ■ Ventral ●



LOOKING for the
BASIC TOWER HARNESS
to fulfill **YOUR NEEDS**

KARAM RHINO HARNESSES
PN 21, PN 12 & PN 11 is all **YOU NEED**



Ref. PN 21

Has Adjustable Shoulders and Thigh Strap with sliding plates for easy attachment of chest strap.

Ref. PN 12

KARAM Rhino PN 12 is a basic CE-compliant harness, having adjustable thigh straps. In addition to the Dorsal D-ring, this Harness is also provided with 2 front-attachment textile loops for fall arrest.

Ref. PN 11

KARAM Rhino PN 11 is a basic CE-compliant harness, having adjustable thigh straps, and a Dorsal D-ring for fall arrest.

Use Karabiner with Captive Pin (page 19). Use Extension Band for easy reach to Dorsal D-ring (page 20)

Ref. No.	Material	Standard	Application	Attachment Point				Weight	Adjustability
				Dorsal	Sternal	Lateral	Ventral		
PN 21	Polyester	EN 361:2002	FA	✓				1100 gms	Adjustable shoulder, thigh-straps
PN 12	Polyester	EN 361:2002	FA	✓	✓			900 gms	Adjustable thigh-straps
PN 11	Polyester	EN 361:2002	FA	✓				800 gms	Adjustable thigh-straps

ELASTO

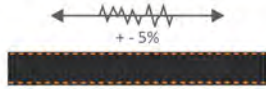

KARAM Elasto Range constitutes special stretchable Harnesses designed for total wearer comfort. The Elastic Webbing used in these Harnesses provides for greater freedom of movement. It allows the wearer to twist and flex freely during long hours of work.

The Metal Components in this range are made up of stainless steel for excellent corrosion protection.

These Harnesses are an Ideal Choice for working on Transmission Towers.

KARAM ADVANTAGE

- Stainless Steel Metal Components
- Elasticated Webbing

**so that you can
TWIST AROUND FREELY
while working!!**



Ref. PN 74

This special stretchable Harness PN 74 moves along with the body of the user while working at height.

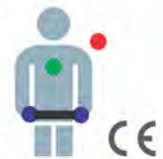

Ref. PN 94

High in Strength and Ergonomics, PN 94 is specifically designed for long hours of work during work positioning at height

Use Karabiner with Captive Pin (page 19). Use Extension Band for easy reach to Dorsal D-ring (page 20)

Ref. No.	Material	Standard	Application	Attachment Point				Weight	Adjustability
				Dorsal ☒	Sternal ☐	Lateral ☐☐	Ventral ☐		
PN 74	Polyester	EN 361:2002	FA	✓	✓			1300 gms	Adjustable shoulder & thigh-straps
PN 94	Polyester	EN 361:2002 EN 358:1999	FA+WP	✓	✓	✓		1800 gms	Adjustable shoulder & thigh-straps

* FA = Fall Arrest; WP = Work Positioning



VEST-HARNESS™

Equipped with Multiple Pockets, KARAM Vest-Harnesses are specially designed into mesh net Vest for tangle free body wear.

for HIGH VISIBILITY
and SAFE WORKING
at HEIGHTS



Ref. PN 20

Consisting of Dorsal D-ring with two front attachment textile loops for fall arrest, this Vest Harness has all the adjustability features. In addition to the multiple pockets for convenient and safe item storage, this Vest Harness also has inside pocket for storage of leg straps when not in use. Equipped with Double Durable zipper for adjustable width to suit all sizes, PN 20 also has Velcro stitched on the D-Ring window provided at the back of the vest for preventing it from slipping into the vest.



Ref. PN 20 (RO)

PN 20(RO) is a specially designed Vest Harness built into the Fluorescent Orange Reflective Vest for higher visibility at night. Along with all the adjustability features, this Vest Harness has Double Durable zipper for adjustable width to suit all sizes. Reflective tapes are stitched on to the vest for increased visibility.



Ref. PN 20 (RG)

Equipped with all the features of basic harness, PN 20(RG) is built into the Fluorescent Green Reflective Vest for higher visibility at night. This Comfortable Vest Harness also has Velcro stitched on the D-Ring window provided at the back of the vest for preventing it from slipping into the vest and has double durable zipper for snug fit. Reflective tapes are stitched on to the vest for increased visibility

Provided with Reflective Tapes

Ref. No.	Material	Standard	Application	Attachment Point				Weight	Adjustability
				Dorsal	Sternal	Lateral	Ventral		
PN 20	Polycoton	EN 361:2002	FA	✓	✓			1600 gms	Adjustable chest, shoulder & Thigh Straps
PN 20 (RO)	Polycoton	EN 361:2002	FA	✓	✓			1520 gms	Adjustable chest, shoulder & Thigh Straps
PN 20 (RG)	Polycoton	EN 361:2002	FA	✓	✓			1540 gms	Adjustable chest, shoulder & Thigh Straps

Conforming to IS 3521:1999



KARAM offers a wide range of Fall Protection Harnesses conforming to ISI standards, which comes with all the features of Safety to fight the fatalities of such events.

Manufactured from new advanced Polyester Webbing, and equipped with specially designed easy-to-use buckles for attachment, the KARAM Series of E-con Harnesses provide an easy solution to most fall hazard situations.

E-CON SERIES of FULL BODY HARNESSES equipped with all the essential features to provide **SAFETY** for **COMPLIANCE**



Ref. PN 14
Full Body Harness, for Controlled Descent (Class D)

Consisting of Dorsal & Sternal D-ring for fall arrest, this Harness is best suited for Controlled Descent in Confined Space.



Ref. PN 16
Full Body Harness, for Basic Fall Arrest (Class A)

Equipped with adjustable chest & thigh straps, PN 16 is the basic Harness for fall arrest.

Ref. No.	Material	Standard	Application	Attachment Point				Weight	Adjustability
				Dorsal 	Sternal 	Lateral 	Ventral 		
PN 14	Polyester	IS 3521:1999	FA	✓	✓			870 gms	Adjustable thigh straps
PN 16	Polyester	IS 3521:1999	FA	✓				820 gms	Adjustable chest & thigh straps



SAFETY for COMPLIANCE



Ref. PN 17
Full Body Harness, for Positioning (Class P)

Along with all the features of PN 16, PN 17 has two lateral D-Rings at the sides for positioning on Tower.



Ref. PN 18
Full Body Harness, for Tower Climbing (Class L)

Equipped with all the features of basic harness, PN 18 is the best Harness for Tower Climbing.



Ref. PN 18 (H)
Full Body Harness, for Tower Climbing (Class L)

With Dorsal & Sternal D-Ring for fall arrest, PN 18(H) has straight thigh straps for more comfort to the user.

Ref. No.	Material	Standard	Application	Attachment Point				Weight	Adjustability
				Dorsal ☒	Sternal ☐	Lateral ☐☐	Ventral ☐		
PN 17	Polyester	IS 3521:1999	FA+WP	✓		✓		1200 gms	Adjustable chest & thigh straps
PN 18	Polyester	IS 3521:1999	FA	✓	✓			1140 gms	Adjustable chest, shoulder & thigh straps
PN 18(H)	Polyester	IS 3521:1999	FA	✓	✓			1250 gms	Adjustable chest, shoulder & thigh straps



Conforming to IS 3521:1999

SAFETY for COMPLIANCE



Ref. PN 19
Full Body Harness, for Entry & Exit in Confined (Class E)

PN 19 is the Harness specifically meant for lowering or raising of personnel & Rescue in Confined space.

KARAM E-CON Harnesses also come with an option of Polypropylene Lanyard of 3m spliced at the Dorsal D-ring.

Link Connecting Polypropylene Rope Lanyard, One Side Loop & Other Side Hook PN 121

Ref. PP 204



Link Connecting Polypropylene Rope Lanyard, One Side Loop & Other Side Hook PN 131

Ref. PP 206



Call **KARAM** Safety Expert for further advise
 Toll Free No.: 1800 103 7085

Ref. No.	Material	Standard	Application	Attachment Point				Weight	Adjustability
				Dorsal	Sternal	Lateral	Ventral		
PN 19	Polyester	IS 3521:1999	FA + R	✓				1010 gms	Adjustable chest & thigh-straps



Ref. STS 01

Care by **KARAM** even after a Fall !
Avoid the effects of Suspension Trauma with

Suspension INTOLERANCE Strap

- ▶ Extremely effective; specially designed to help relieve the negative effects of Suspension Trauma.
- ▶ Compact and Light-weight. Does not hamper with the activity of the worker while at work.
- ▶ Allows the suspended worker to stand up in his harness to relieve pressure.
- ▶ Easy to attach to the Harness with the help of the textile loop and velcro provided.
- ▶ Easy deployment; operation is fool-proof.

The KARAM Suspension Intolerance Strap can be used by a victim of fall to combat the ill effects of Suspension Trauma, while he waits for his rescue, suspended in his Harness.

This Strap is provided placed inside 2 light weight zipped pouches, which can be conveniently worn on the Thigh straps on both left & right sides of the Harness with the help of textile loop and Velcro.

In the event of a fall, the victim can easily zip-open the pouches and attach together the deployed webbing straps with the help of a convenient buckle.



KARAM provides Harnesses fitted with the Suspension Intolerance Straps on request.

Steps to USE the KARAM Suspension Intolerance Strap



1
Un-zip the pouches fitted on both sides of Harness



2
Hold the 2 straps together



3
Connect the straps with each other making a loop with the help of easy-to-use buckle.



4
Put your feet into the loop



5
Stand onto the loop, so that the thigh straps are free to move



6
Adjust the sit strap towards the front to release pressure and give a seat-posture.

TOOLS LANYARD

Accidents are also known to occur when tools fall from the hand of a worker who is using them while working at a height. KARAM introduces a new Tools Lanyard which can be connected to the belt of the Harness at one end and has a loop at the other end to hold a tool of weight of upto 10kg.



KARAM Twin Tools Lanyard Ref. TL 02

- ▶ This lanyard comes as a **bright coloured elasticated** 16mm tubular webbing, having a relaxed length of 85 cm (so that the lanyard does not unnecessarily come in the way while working), and extended length of 135cm (to allow maximum reach while using the tool).
- ▶ The **Y-shaped lanyard** allows the user to attach and carry 2 tools.
- ▶ The Lanyard can be easily attached to the **Waist belt** of the Harness with the help of a light-weight Karabiner.
- ▶ Convenient '**Y**'stretch-Lanyard for Tool Holding.
- ▶ Provided with a light-weight Karabiner for attachment to the user's belt.
- ▶ Can holds Tools up to 10kg.



New



Call **KARAM** Safety Expert
for further advise
Toll Free No.: 1800 103 7085

EASY SEAT

Ref. IMP 004

When **PROLONGED SUSPENSION** is **REQUIRED...**



This accessory by KARAM can be attached to KARAM Harnesses -**Magna 3, PN 56 and PN 57** having a central D-ring at the waist level (ventral) to which the Karabiner is attached.

When done, the Easy Seat provides a comfortable seating for extended time during long hours of work, suspended at a height.

Easy Seat

Ref. IMP 004

- ▶ The Aluminium re-enforcement in the Easy-seat makes it robust yet light in weight, weighing not more than 1.3 Kg.
- ▶ The loops at the end of the polyester webbing straps can be easily attached to the ventral D-ring of the Harnesses mentioned.
- ▶ Straps are adjustable
- ▶ 3 equipped loops
- ▶ Easy positioned on the back when not in use.
- ▶ Soft cushioned sides prevents the webbing straps from cutting into the thighs
- ▶ The webbing straps have a breaking strength of more than 23 kN.
- ▶ Ergonomic & comfortable working chair.
- ▶ Aluminium reinforcement inside

WEBBING

Material : Polyester
 Width : 44±1mm
 Breaking Strength : 23kN

METAL COMPONENTS

Material : High strength steel
 Finish : Black powder coated
 Weight : 1280 gm ± 1





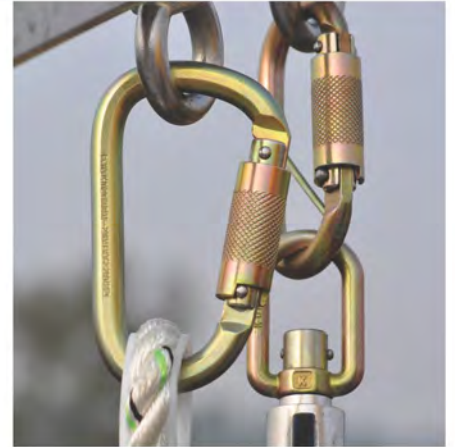

The KARAM range of Hooks and Connectors come with the following special features:

- ▶ Are openable by minimum 2 deliberate consecutive manual actions.
- ▶ A range of Manual & Automatic Locking Hooks and Connectors.
- ▶ Tested for both Gate function and Gate Resistance.
- ▶ Tested for corrosion resistance for minimum 72 hours of salt spray testing.
- ▶ Certified as per EN. Some connectors are also certified as per ANSI.

Hooks & Connectors



TESTS CARRIED out on all type of HOOKS & CONNECTORS

Extensive tests are carried out on all Hooks & Connectors in KARAM to ensure highest level of performance



Testing of basic raw material rods/ sheets for correct composition on spectrometer.



Online inspection during all intermediate processes.

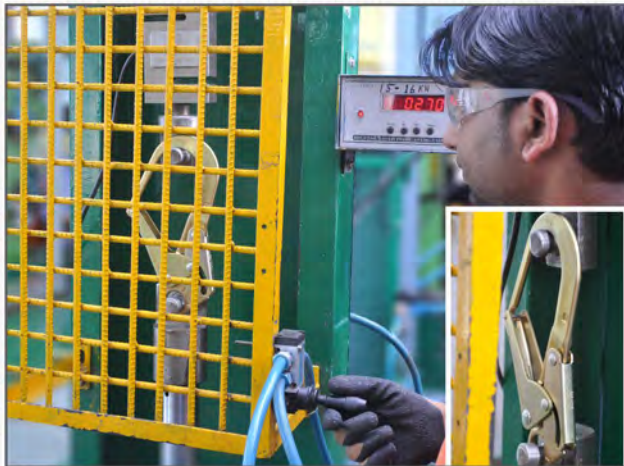

100 % proof load testing at 16 kN post assembly of components.



Static Strength testing on randomly drawn samples, lot wise for major axis, minor axis, gate side, strength and gate-face strength as per requirement.



Salt-spray testing for corrosion resistance after zinc plating.

KARAM[®] INTRODUCES

Two **NEW CONNECTORS**

for SAFE CONNECTIONS

Guaranteed at ALL TIMES...

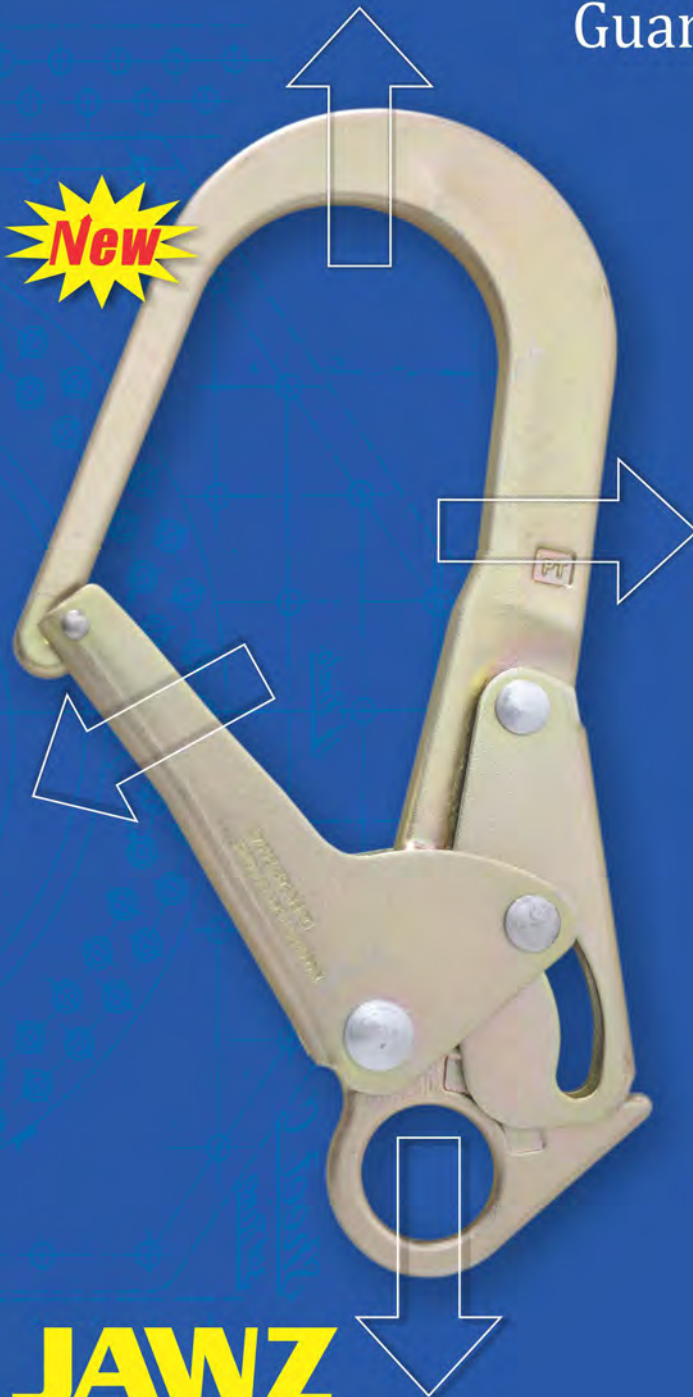

JAWZ
Ref. PN 140

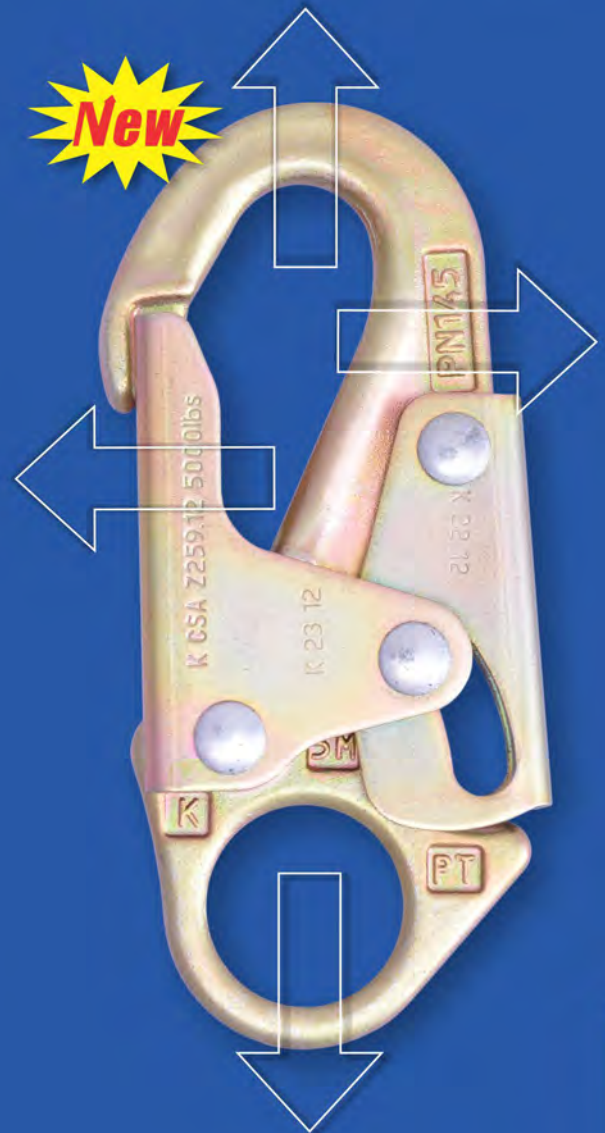

JED-I
Ref. PN 145



Call **KARAM** Safety Expert
for further advise
Toll Free No.: 1800 103 7085



JAWZ / JED-I

KARAM INTRODUCES

JAWZ & JED-I Connectors..



Revolutionizing Connections in FALL PROTECTION..

A popular phrase in fall protection is- **"Your system is as strong as the strength of its weakest link"**.

Hence it is extremely important to recognize the "weak link" in your system to ensure that it is strong enough to sustain the impact of a fall!



Major load bearing axis

A close analysis of failure of connectors has revealed that when a fall took place, the Connector did not necessarily get impacted only along its major load bearing axis as shown in figure.

Instead, the impact of force was also felt along the side of its Gate, or along the face of its Gate!

This has led to breaking of the connector from its gate when impacted with such a force resulting in a fall.

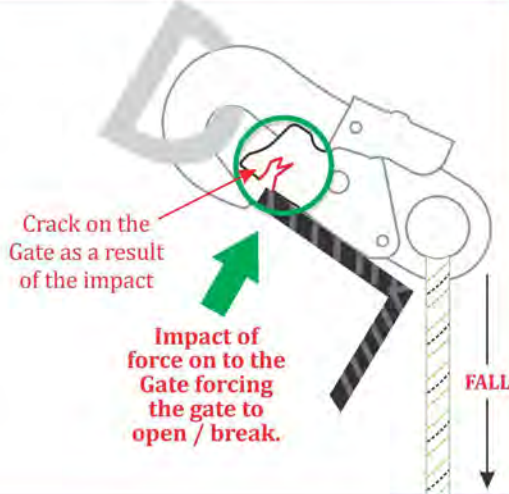



JED-I HOOK
(Ref. PN 145)



JAWZ HOOK
(Ref. PN 140)

Existing Norms like ISI & EN only test the connector along its major load bearing axis for its static strength, the strength along the other planes have been overlooked.

But KARAM understands that falls take place not entirely adhering to laboratory conditions.

KARAM has therefore ventured to think beyond just the requirement of the Norms, and instead worked towards solving the problem so as to ensure complete safety of a worker working at heights.

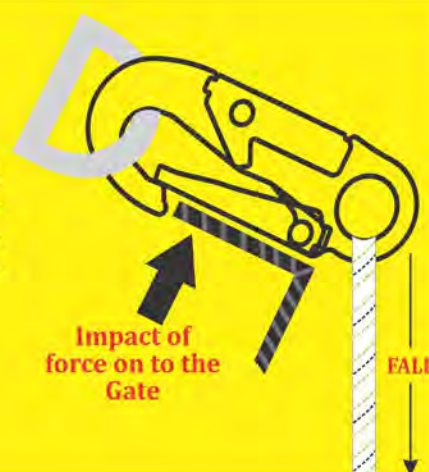

KARAM Jawz & Jed-I Connectors do not break because they have enhanced Gate Strength.

KARAM's JAWS and JEDI Connectors have been specially designed to take up **additional load of minimum 16 kN along the Gate side and Gate front**, ensuring that the two connectors are strong enough from all sides, and not just along their its major load bearing axis

These connectors pass the latest ANSI Z 359.12-2009 and EN 362:2004 standards, and hence offer the maximum safety to the user.

Steel Hooks & Connectors

KARAM Provides Steel Karabiners having screw-locking, twist-locking & triple-locking features, to suit a wide range of applications.

Ref. PN 103
Steel Screw Link



Ref. PN 111
Steel Quarter Turn Locking Karabiner



* see the box below

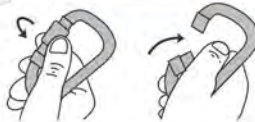

Ref. PN 112
Steel Screw-Locking Karabiner

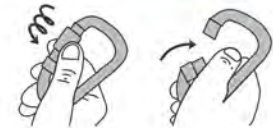

Ref. PN 113
Steel Quarter Turn-Locking Karabiner



* see the box below

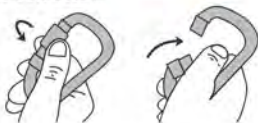

Ref. PN 113 BE
Bulb Type Steel Quarter Turn-locking Karabiner



* see the box below



To ensure optimal efficiency, KARAM Karabiners PN 113B use the Keylock System: The body/gate interface does not have a Hook that could snag on Anchors, Ropes, Harness equipment loops, etc.

* Also available with CAPTIVE PIN on request



This is an Additional Pin fitted to the Karabiner to prevent it from disengaging from the Lanyard. The code for the product is written as the Ref. No. of the product along with (C), for eg. PN 112 (C)

Ref. No.	Material	Gate Opening	Minimum Breaking Strength	Finish Available	Conformity
PN 103	Alloy Steel	11 mm	25 kN	Silver	EN 362:2004 Class Q
PN 111	Alloy Steel	16 mm	25 kN	Silver/Golden Yellow Galvanized	EN 362:2004 Class B
PN 112	Alloy Steel	18 mm	25 kN	Silver/Golden Yellow Galvanized	EN 362:2004 Class B, Class M
PN 113	Alloy Steel	22.5 mm	25 kN	Silver/Golden Yellow Galvanized	EN 362:2004 Class B
PN 113BE	Alloy Steel	22.5 mm	25 kN	Silver/Golden Yellow Galvanized	EN 362:2004 Class B

Ref. PN 132
Steel Tower Hook



CE



Ref. PN 133
Steel Scaffold Hook



CE



Ref. PN 134
Steel Tower Hook



CE



Ref. PN 135
Steel Tower Hook



CE



Ref. PN 152
Steel Quarter Turn locking Hook



CE



* Also available with CAPTIVE PIN of request



This is an Additional Pin fitted to the Karabiner to prevent it from disengaging from the Lanyard. The code for the product is written as the Ref. No. of the product along with (C), for eg. PN 115 (C)

Ref. No.	Material	Gate Opening	Minimum Breaking Strength	Finish Available	Conformity
PN 132	Alloy Steel	85 mm	25 kN	Silver/Golden Yellow Galvanized	EN 362:2004 Class T
PN 133	Alloy Steel	55 mm	25 kN	Silver/Golden Yellow Galvanized	EN 362:2004 Class T
PN 134	Alloy Steel	50 mm	25 kN	Silver/Golden Yellow Galvanized	EN 362:2004 Class T
PN 135	Alloy Steel	60 mm	25 kN	Silver/Golden Yellow Galvanized	EN 362:2004 Class T
PN 152	Alloy Steel	20.5 mm	25 kN	Silver/Golden Yellow Galvanized	EN 362:2004 Class T



Call **KARAM** Safety Expert
for further advise
Toll Free No.: 1800 103 7085

Anchorage Hooks

Our range of Stainless Steel Anchorage hooks offer openings from 75mm to 140mm. Buffed and polished finish make them unique when compared to other options available in the market. *All Aluminium Hooks & Connectors are available in Colours: Red, Golden, Clear, Green & Blue.*

Ref. PN 141
Anchorage Hook

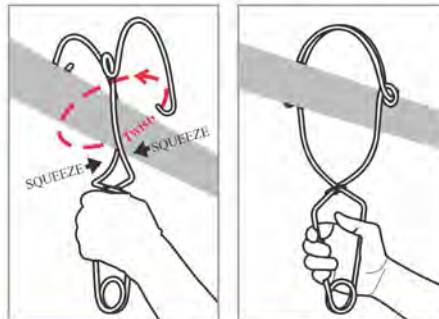

Ref. No.	Material	Gate Opening	Minimum Breaking Strength	Finish Available	Conformity
PN 141	Stainless Steel	140 mm	23 kN	Polished	EN 362:2004 Class A
PN 142	Stainless Steel	110 mm	23 kN	Polished	EN 362:2004 Class A
PN 143	Stainless Steel	75 mm	23 kN	Polished	EN 362:2004 Class A

Aluminium Hooks & Connectors

Where it is important to carry light-weight Connectors at height to provide the maximum comfort as well safety to the user; this range of Aluminium Connectors by KARAM fulfills all the required needs. Manufactured from high quality Aluminium alloy, these Connectors come in highly engineered designs, conforming to all the clauses laid down in the EN norms.

Ref. PN 116 F
Aluminium Screw-locking Karabiner (Forged)



* see the box below

Ref. PN 117 F
Aluminium Quarter Turn-locking Karabiner (Forged)



* see the box below

Ref. PN 118 F
Aluminium Triple Action locking Karabiner (Forged)



* see the box below

Ref. No.	Material	Gate Opening	Minimum Breaking Strength	Finish Available	Conformity
PN 116 F	Aluminium Alloy	22 mm	23 kN	Natural Silver/ Coloured, Anodized	EN 362:2004 Class B
PN 117 F	Aluminium Alloy	21 mm	23 kN	Natural Silver/ Coloured, Anodized	EN 362:2004 Class B
PN 118 F	Aluminium Alloy	21 mm	23 kN	Natural Silver/ Coloured, Anodized	EN 362:2004 Class B

* Also available with CAPTIVE PIN of request



This is an Additional Pin fitted to the Karabiner to prevent it from disengaging from the Lanyard. The code for the product is written as the Ref. No. of the product along with (C), for eg. PN 116 F (C)

Ref. PN 136
Aluminium Rebar Hook



Ref. PN 139
Aluminium Tower Hook



Ref. No.	Material	Gate Opening	Minimum Breaking Strength	Finish Available	Conformity
PN 136	Aluminium Alloy	60 mm	23 kN	Natural Silver/ Coloured, Anodized	EN 362:2004 Class T
PN 139	Aluminium Alloy	60 mm	23 kN	Natural Silver/ Coloured, Anodized	EN 362:2004 Class T

Tests Carried out on all types of CONNECTORS as per EN 362:2004

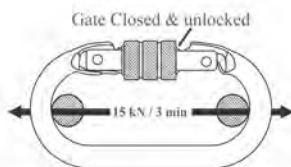

The Karabiner must not Break

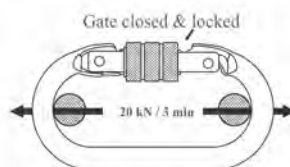

The Karabiner must not Break

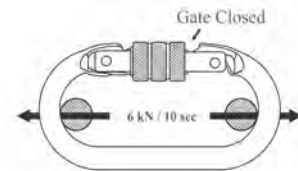

After the test, the gate shall open like new one. (Gate Function)

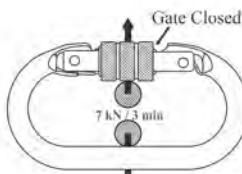

The Karabiner must not Break (Minor Axis)

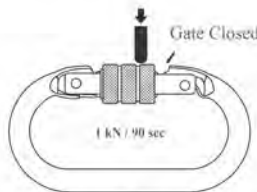

After the test, the gate shall open like the new one. Gate Resistance (Gate Face)

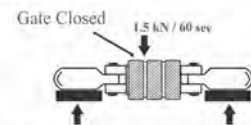

After the test, the gate shall open like new one. Gate Resistance (Gate Side)



Call **KARAM** Safety Expert
for further advise
Toll Free No.: 1800 103 7085





A Lanyard is described as a connecting element of a system.

The Fall Arrest Lanyards incorporate a shock absorbing element which is capable of limiting the force felt on the body of the worker to less than 6 kN.

Depending Upon the specific usage, Lanyards are classified as follows:

- ▶ **Work Positioning Lanyards**-used for work positioning
- ▶ **Restraint Lanyards**-used for Restraint
- ▶ **Fall Arrest Lanyards**-come incorporated with an energy absorber to reduce the impact of fall, and hence are used for fall arrest.
- ▶ **Forked Lanyard**-KARAM also provides a range of forked lanyards that can be used to move up or down, or along the sides while remaining connected at all times.

KARAM offers an exhaustive range of lanyards made of twisted rope, kernmantle rope or webbing, and different Connector combinations, as per the need of the user.

Lanyards

WORK POSITIONING LANYARDS



KARAM offers a range of Work Positioning Lanyards which can be used by the worker to position himself at a height in a safe and supported manner, and work with both hands free.

KARAM Work Positioning lanyards can be easily adjusted for length, using various adjustment devices that come with the lanyard.

It is important to note that a **Work Positioning system is not fall protection equipment**. It is hence mandatory to use specific Fall Arrest Lanyards and other such equipment along with Work Positioning Systems to ensure safety of the worker at a height.

The Work Positioning Lanyard is used by connecting the two ends of the lanyard to the two lateral D-rings on the Full Body Harness of the user. The length can be easily adjusted to suit the application.

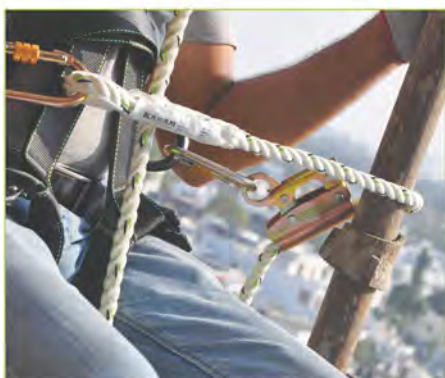

KARAM Work Positioning Lanyards have a Minimum Breaking Strength of 15 kN, and are certified as per EN 358:1999.



Protective Sleeve (PR 02)

KARAM offers the choice of using an Abrasion-Resistant Protective Sleeve over the Work Positioning Rope Lanyards. This Sleeve

of length 30cm is provided incorporated onto the rope lanyard. This Sleeve works to prevent any abrasion of the rope when the lanyard is used around a structure in the event of work – positioning.



Ref. PN 241 (PR).



Work Positioning Lanyard with Ring type Adjuster Ref. PN 241

- ▶ Made up of 14mm dia polyamide 3-strand twisted rope.
- ▶ Has a Manual Ring-type adjuster of forged alloy steel.
- ▶ Maximum length is 2.0m.
- ▶ Easy to connect Steel Karabiners (PN 112) at both the ends for attachment.
- ▶ Conforms to EN 358:1999.
- ▶ Also available with a 30cm long protective Covering Sleeve Ref. PN 241 (PR).

Work Positioning Lanyard with Grip Adjuster Ref. PN 242

- ▶ Made up of 14mm dia polyamide 3-strand twisted rope.
- ▶ Equipped with convenient Rope-grab adjuster for easy length adjustment.
- ▶ Maximum length is 2.0m.
- ▶ Easy to connect Steel Karabiners (PN 112) at both the ends for attachment.
- ▶ Conforms to EN 358:1999.
- ▶ Also available with a 30cm long protective Covering Sleeve Ref. PN 242 (PR).



Ref. PN 242 (PR).



Webbing Work Positioning Lanyard Ref. PN 243

- ▶ Made up of 33mm wide polyester webbing.
- ▶ Manual Ring type adjuster of forged alloy steel.
- ▶ Easy to connect Steel Karabiners (PN 112) at both the ends for attachment.
- ▶ Maximum Length is 2.0m.
- ▶ Conforms to EN 358:1999.

Work Positioning Lanyard with Ring Adjuster Ref. PN 244

- ▶ Made up of Kernmantle rope of dia 11mm.
- ▶ Easy to connect Steel Karabiners (PN 112) at both the ends for attachment.
- ▶ Manual Ring type adjuster made of forged Alloy Steel.
- ▶ Maximum length is 2.0m.
- ▶ Conforms to EN 358:1999.
- ▶ Also available with a 30cm long protective Covering Sleeve Ref. PN 244 (PR).

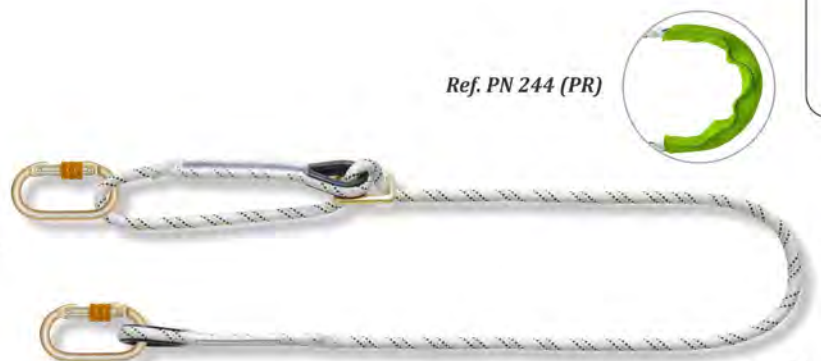

Ref. PN 244 (PR)



Ref. PN 245 (PR)

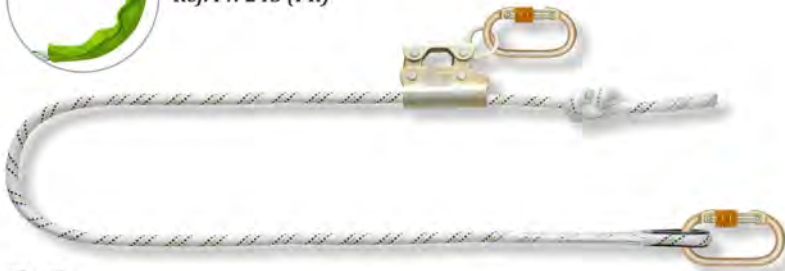

Work Positioning Lanyard with Grip Adjuster Ref. PN 245

- ▶ Made up of Kernmantle rope of dia 11mm.
- ▶ Equipped with convenient Rope-grab adjuster for easy length adjustment.
- ▶ Maximum Length is 2.0 m.
- ▶ Easy to connect Steel Karabiners (PN 112) at both the ends for attachment.
- ▶ Conforms to EN 358:1999.
- ▶ Also available with a 30cm long Protective Covering Sleeve Ref. PN 245 (PR).

Ref. PN 246 (PR)



Work Positioning Lanyard with Grip Adjuster Ref. PN 246

- ▶ Made up of 14 mm dia polyamide 3 strand twisted rope.
- ▶ Equipped with convenient Stainless Steel Rope Grab Adjuster for easy length adjustment.
- ▶ Maximum Length is 2.0 m.
- ▶ Easy to connect Steel Karabiners (PN 112) at both the ends for attachment.
- ▶ Conforms to EN 358:1999.
- ▶ Also available with a 30cm long Protective Covering Sleeve Ref. PN 246 (PR).



Ref. PN 247 (PR)



Work Positioning Lanyard with Aluminium Blocker adjuster Ref. PN 247

- ▶ Made up of Kernmantle rope of dia 12mm.
- ▶ Equipped with light weight Aluminium Blocker Rope-grab adjuster for easy length adjustment.
- ▶ Maximum Length is 2.0 m.
- ▶ Easy to connect Steel Karabiners (PN 112) at both the ends for attachment.
- ▶ Conforms to EN 358:1999.
- ▶ Also available with a 30cm long Protective Covering Sleeve Ref. PN 247 (PR).



Call **KARAM** Safety Expert
for further advise
Toll Free No.: 1800 103 7085

RESTRAINT LANYARDS

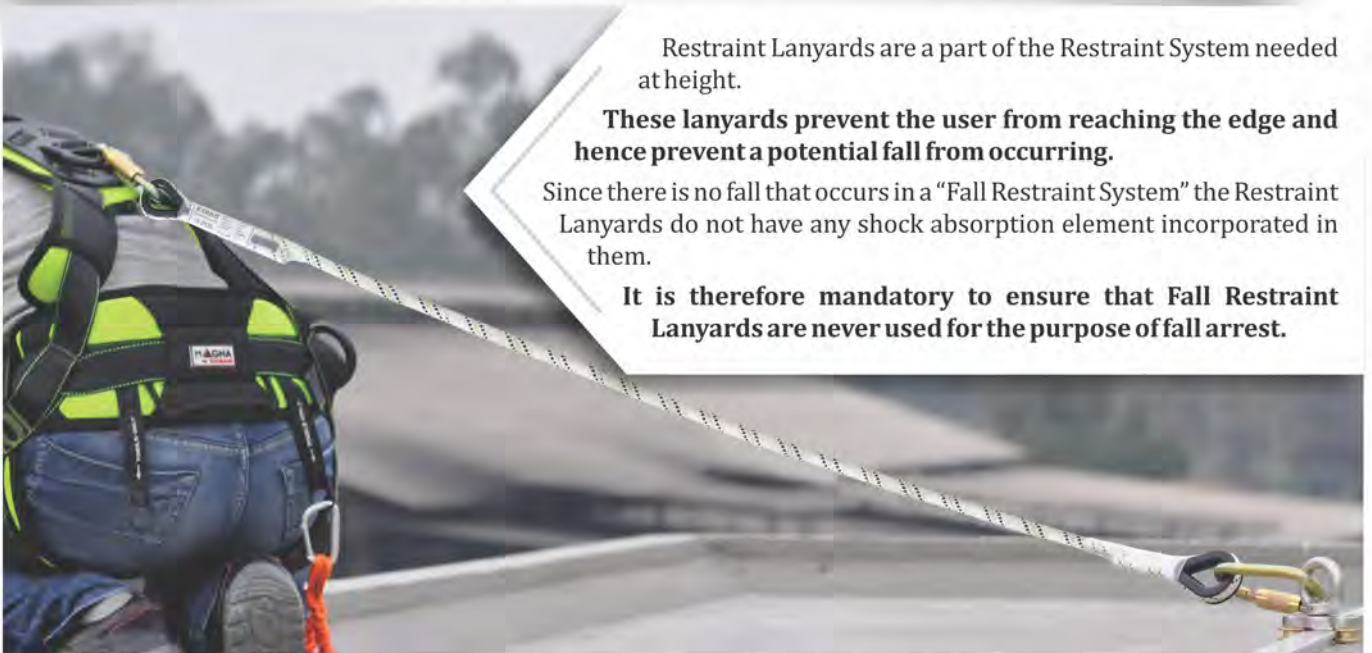

Restraint Lanyards are a part of the Restraint System needed at height.

These lanyards prevent the user from reaching the edge and hence prevent a potential fall from occurring.

Since there is no fall that occurs in a "Fall Restraint System" the Restraint Lanyards do not have any shock absorption element incorporated in them.

It is therefore mandatory to ensure that Fall Restraint Lanyards are never used for the purpose of fall arrest.

KARAM Fall Restraint Lanyards come in various options of connecting element :

- ☞ Twisted Rope Lanyards
- ☞ Kernmantle Rope Lanyards
- ☞ Webbing Lanyards
- ☞ Expandable Lanyards

KARAM Restraint Lanyards are available in different lengths- 1.0m, 1.5m, 1.8m and 2.0m

KARAM offers all the Lanyards in different configurations of connectors, as per the need of the user.



Refer to the table given below to understand the various features of the different lanyards :-

Type of Lanyards	Prevents Undue Twisting	Prevents Grime and Dust	Light in Weight	With Anti-Aging Tracer Yarn	Easy to Clean	Minimizes Trip Hazards	Prevents Water Absorption
Twisted Rope	-	-	-	✓	✓	-	-
Kernmantle Rope	✓✓	✓✓	✓	✓	✓✓	-	✓✓
Webbing Lanyards	✓	✓✓	✓	✓	✓✓	-	✓✓
Expandable Webbing Lanyards	✓	✓	-	-	-	✓	-

DESIGN YOUR OWN CONNECTING ELEMENTS

Now **DESIGN** Your **LANYARD** in your own **STYLE & REQUIREMENT!**

KARAM provides you with an option to customize your Restraint Lanyards as per your own job specific needs.

- Variety of Hooks and Connectors are available for connection on both anchorage and termination ends.
- All lanyards with different combination of connectors mentioned below are individually certified as per EN 354:2010 and have a minimum breaking strength of 22 kN.
- Resistant twisted, Kernmantle, and Webbing rope lanyards are available in lengths- 1.0m, 1.5m, 1.8m & 2.0m. *The Expanded length of the Resistant Expandable Lanyard should not exceed 2.0m.*



Always remember the length of your lanyard should not exceed 2.0 m.

Now Conforming to Latest Standard EN 354:2010

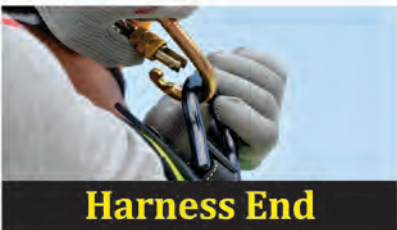

Harness End





**Each Lanyard offers you distinct features.
Choose the lanyards that best suit your
requirement.**

**Now Conforming to
Latest Standard
EN 354:2010**



Restraint Twisted Rope Lanyards

- ▶ They are made up of 12mm dia Polyamide Twisted Rope.
- ▶ The spliced end is protected with a strong transparent protective covering sleeve, this not only protects the splicing, but also makes the splicing visible for easy inspection prior to use.
- ▶ The loops at the end are protected by an abrasion resistant thimble, this prevents the rope from being damaged by the metallic contact of the connector:



- ▶ The rope also has a coloured tracer strand which loses its colour in due course of time, to show that the Lanyard is now unfit for further use.
- ▶ Available in lengths 1.0m, 1.5m, 1.8m, and 2.0m.
All Lanyards with different combinations of connectors are individually certified as per **EN 354 : 2010** and have a minimum breaking strength of 22 kN.



Restraint Kernmantle Rope Lanyards

- ▶ This range of Lanyards is made from high quality Kernmantle rope of 11mm dia.
- ▶ They are cross stitched and are protected with a strong transparent covering sleeve. This not only protects the ends, but also makes the stitches visible for easy inspection prior to use.
- ▶ The loops at the end are protected by an abrasion resistant thimble. This prevents the rope from being damaged by the metallic contact of the connector.



- ▶ The rope also has a coloured tracer strand which loses its colour in due course of time, indicating that the Lanyard is now unfit for further use.
- ▶ Available in lengths 1.0m, 1.5m, 1.8m, and 2.0m.
- ▶ All Lanyards with different combinations of connectors mentioned below are individually certified as per **EN 354 : 2010** and have a minimum breaking strength of 22 kN.

KARAM Advantage :

- ▶ Kernmantle Energy Absorbing Lanyards are considerably resistant to collection of grime and dust.
- ▶ The sheath of the rope protects the inner core & provides much better longevity through the line.



Restraint Webbing Lanyards (44mm)

- ▶ KARAM offers a wide range of Webbing Lanyards made from high tenacity polyester yarn having a different configuration of connectors on the ends.
- ▶ The loops at the ends are protected by an abrasion resistant covering. This prevents the webbing from being damaged by the metallic contact of the connector.
- ▶ Available in lengths 1.0m, 1.5m, 1.8m, and 2.0m.
- ▶ All Lanyards with different combinations of connectors mentioned below are individually certified as per **EN 354 : 2010** and have a minimum breaking strength of 22 kN.

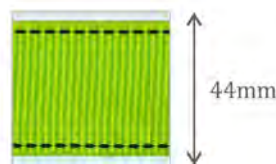

- ▶ The Webbing Lanyards in this section are made up of 44mm wide polyester webbing.



Restraint Expandable Lanyards

- ▶ These Lanyards are ideal for use in conditions where there are chances of the user tripping over the Lanyard. **The Elastic nature of the lanyard reduces its actual effective length thereby reducing trip hazards.**
- ▶ All Lanyards with different combinations of connectors mentioned below are individually certified as per **EN 354:2010** and have a minimum breaking strength of 22 kN.

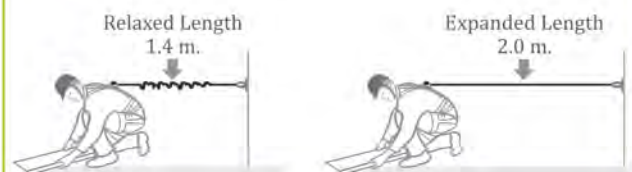

**Call KARAM Safety Expert
for further advise
Toll Free No.: 1800 103 7085**

KARAM®

ENERGY ABSORBING LANYARDS

KARAM offers a wide range of Fall Arrest Lanyards which come incorporated with the KARAM Energy Absorber, in different connector combinations, and made of Twisted Rope, Kernmantle Rope, or Webbing, for the user to make his choice. These lanyards are all tested and certified as per EN 355:2002.



The **KARAM** Energy Absorber packs now available with Impact Indicator which opens up when there is a fall.



- ⇒ KARAM Energy Absorber Pack consists of a special white inner polyamide core which absorbs the arresting forces in the event of a fall.
- ⇒ The coloured webbing serves as a back up.
- ⇒ The clear protective covering helps in easy and fast visual inspection.

KARAM ENERGY ABSORBING PACKS (ENERGY ABSORBER)

Ref. PN 300



KARAM Energy Absorber PN 300 is made up of 44mm wide webbing and is shrink wrapped. It reduces the impact of fall to less than 6kN and conforms to EN 355:2002.

The minimum fall clearance distance required when using this energy absorber for a 2m lanyard is = 6m.

Ref. PN 400



KARAM Energy Absorber PN 400 is smaller, and made up of 35mm wide webbing and is shrink wrapped. It is lighter in weight. It reduces the impact of fall to less than 6kN and conforms to EN 355:2002

All KARAM range of Fall Arrest lanyards can be provided with this Energy Absorber PN 400. The minimum fall clearance distance required when using this energy absorber for 2m lanyard is = 5.8m



How does the ENERGY ABSORBER WORK ?

In the event of a fall the special webbing inside the Energy Absorber opens up. This opening of the webbing takes up most of the jerk which is felt as an impact when a fall occurs. Hence finally very little jerk is felt on the body of the worker.

We can therefore imagine that if this Energy Absorber is absent from a fall protection system, the forces which are felt on the body of the worker can be very high and can result in injury.

Always use Energy Absorbing Lanyards for fall arrest applications.

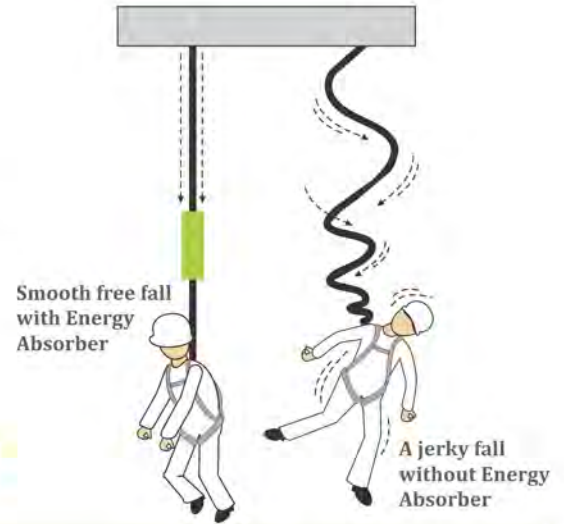

What Should be the Length of a KARAM FALL ARREST LANYARD

The standard maximum length of the Fall Arrest Lanyard is 2 meters. Important thing to note is to have a lanyard long enough to be user friendly, however, kept as short as possible, to minimize the free fall distance. All KARAM fall arrest lanyards are tested and certified as per EN 355:2002 for their maximum length of 2m.



Minimum fall clearance distance required when using an ENERGY ABSORBING LANYARD

It is extremely important to know the fall clearance distance while working at a height using the appropriate Fall Protection System.

While anchored vertically above the head level, the length of the lanyard used and the elongation of the Energy Absorber which occurs in the event of a fall become two of the important factors to determine the fall clearance.

Always check for the minimum Fall-clearance distance so that the risk of hitting an obstacle below is not there.

In the worst case where the user has climbed above the point of anchorage, and has a free fall of 4 meters before the lanyard has been activated, the minimum clearance required is 6.25 meters below the anchorage.

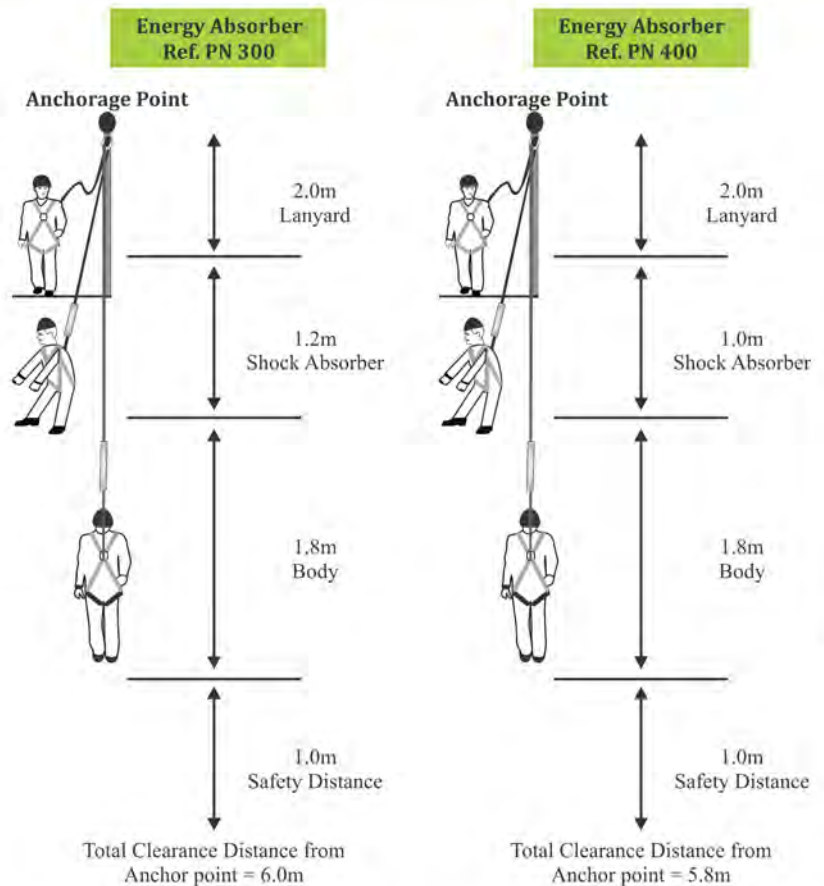

The Fall clearance is the safe clearance distance calculated from the anchorage point downwards.

DESIGN YOUR OWN CONNECTING ELEMENTS

Now DESIGN Your ENERGY ABSORBING LANYARDS in your own STYLE & REQUIREMENT!

KARAM provides you an option to customize your Energy Absorbing Lanyards as per your own job specific needs.

- Variety of Hooks and Connectors are available for connection on anchorage and termination ends.
- All lanyards with different combination of connectors mentioned below are individually certified as per EN 355:2002

Now Conforming to Latest Standard EN 355:2002



CHOOSE YOUR CONNECTOR



i Always remember the length of your lanyard should not exceed 2.0 m to minimize free fall distance

Choose your Energy Absorber



CHOOSE YOUR CONNECTING ELEMENTS

with Impact Indicator



CHOOSE YOUR CONNECTOR







Each Lanyard offers you distinct features. Choose the lanyards that best suits your requirement.

Energy Absorbing Twisted Rope Lanyards



Significant Features:

- ▶ They are made up of Polyamide Twisted Rope, 12mm dia and have KARAM Energy Absorbing pack (either PN 300 or PN 400) incorporated at the harness end of the Lanyard.
- ▶ The spliced end is protected with a strong transparent protective covering sleeve, this not only protects the splicing, but also makes the splicing visible for easy inspection prior to use.
- ▶ The loops at the end are protected by an abrasion resistant thimble, this prevents the rope from being damaged by the metallic contact of the connector.
- ▶ The rope also has a coloured tracer strand which loses its colour in due course of time, to show that the Lanyard is now unfit for further use.
- ▶ Available in length 1.0m, 1.5, 1.8m, & 2.0m.
- ▶ All Lanyards with different combinations of connectors mentioned below are individually certified as per EN 355 : 2002.

Energy Absorbing Kernmantle Rope Lanyards

- ▶ This range of Lanyards is made from high quality Kernmantle Rope of dia 11mm and have KARAM Energy Absorbing pack (either PN 300 or PN 400) incorporated at the harness end of the Lanyard.
- ▶ They are cross stitched and are protected with a strong transparent covering sleeve. This not only protects the ends, but also makes the stitches visible for easy inspection prior to use.
- ▶ The loops at the end are protected by an abrasion resistant thimble. This prevents the rope from being damaged by the metallic contact of the connector.
- ▶ The rope also has a coloured tracer strand which loses its colour in due course of time, to show that the Lanyard is now unfit for further use.
- ▶ Available in lengths 1.0m, 1.5m, 1.8m, and 2.0m.
- ▶ All Lanyards with different combinations of connectors mentioned below are individually certified as per EN 355 : 2002.

Energy Absorbing Expandable Lanyards

- ▶ These Lanyards are ideal for use in conditions where there are chances of the user tripping over the Lanyard. The Elastic nature of the Lanyard reduces the actual effective length of the Lanyard thereby reducing trip hazards.
- ▶ KARAM offers a wide range of Energy Absorbing Webbing Lanyards which have KARAM Energy Absorbing pack (either PN 300 or PN 400) incorporated at the harness end of the Lanyard and have different configuration of connectors at the ends.
- ▶ All Lanyards with different combinations of connectors mentioned below are individually certified as per EN 355 : 2002.

Relaxed Length
1.4 m.



Expanded Length
2.0 m.



Refer to the Comparative Table given of Page 50 to understand the various features of different Lanyards.



Call **KARAM** Safety Expert for further advise
Toll Free No.: 1800 103 7085

KARAM[®]



Introduces

New

Internal Shock Absorbing Expandable Lanyards

for making connections
of the highest level in
Safety and Ergonomics.



UNIQUE FEATURES:

- ▶ **Lighter in weight:** Since there is no additional shock absorbing pack, this range of lanyards is extremely light in weight.
- ▶ **Minimizes Trip-Hazards:** Since the relaxed length of this lanyard is much less than its expanded length, it does not come in the way of a worker, hence minimizing any trip-hazards.
- ▶ **Comes in configuration of different** combination of connectors, as per choice.
- ▶ **An Impact Indicator** incorporated in the lanyard helps to identify the lanyard that has been subjected to a fall.
- ▶ Tested and Certified as per EN 355:2002.



Call **KARAM** Safety Expert
for further advise
Toll Free No.: 1800 103 7085



DESIGN YOUR OWN CONNECTING ELEMENTS

Now **DESIGN** Your **INTERNAL SHOCK ABSORBING LANYARD** in your own **STYLE & REQUIREMENT!**

- KARAM facilitates its customers to choose and customize their Internal Shock Absorbing lanyards as per their own job specific requirements.*
- A collection of Hooks and Connectors are given below to customize accordingly both at the Anchorage end and the Termination end.
 - Internal Shock Absorbing lanyards come with Energy Absorbing feature incorporated within its core, hence **No Need of any additional Internal Shock Absorbing pack and simultaneously making them lighter in weight to use.**
 - All Lanyards with different combinations of connectors mention below are individually certified as per EN 355:2002, EN 354:2010.

Always remember the length of your lanyard should not exceed 2.0 m to minimize free fall distance





FORKED LANYARDS

KARAM Forked Lanyards come in Twisted Ropes, Kernmantle Ropes and also in 44mm & 30mm wide polyester webbing and offer the facility to move in all directions while remaining safely anchored at all times.



with Impact Indicator



Call **KARAM** Safety Expert for further advise
Toll Free No.: 1800 103 7085

Forked Lanyards

Forked Lanyards (or Y-shaped Lanyards) provide 100% tie-off required during progressive movement from one anchor point to the next, upwards or side-ways.

While using an Energy Absorbing Forked Lanyard make sure that only the Energy Absorber end of the lanyard is connected to the Harness at its Dorsal attachment point. If this is not done so, the shock absorption element gets removed from the system, making it extremely dangerous in the event of a fall.



KARAM Forked Lanyards Tested as per VE 11 of PPE Directive 89/686/EEC

KARAM Forked Lanyards are also subjected to the special 3-point testing as laid down in the VG 11 Procedure to make the Lanyards extra safe for use.

Conforms to : EN 355:2002 + VG11 PPE 63 (Additional Static Strength Test)



CE

Ref. PN 341 (A)



CE

Ref. PN 351

Lanyards	Ref. No.	Connecting Element	Connector at Harness end	Connector at Anchorage end	Length
Kernmantle Rope E.A Forked Lanyard	PN 341 (A)	11 mm dia Kernmantle Rope	Steel Screw -Locking Karabiner PN 112	2 nos. of Aluminium Rebar Hooks PN 136	1.5m, 1.8m & 2.0 m
Twisted Rope E.A Forked lanyard	PN 351	12 mm dia 3 Strands Twisted Polymide Rope	Steel Screw -Locking Karabiner PN 112	2 nos. of Steel Scaffold Hooks PN 131	



CE

Ref. PN 352



CE

Ref. PN 361



CE

Ref. PN 361 (30) (A)



CE

Ref. PN 371 (A)



CE

Ref. JPN341



CE

Ref. JPN351

Lanyards	Ref. No.	Connecting Element	Connector at Harness end	Connector at Anchorage end	Length
Twisted Rope E.A Forked lanyard	PN 352	12 mm dia 3 Strands Twisted Polyamide Rope	Steel Screw -Locking Karabiner PN 112	2 nos. of Snap Hooks PN 121	1.5m, 1.8m & 2.0 m
Energy Absorbing Forked Webbing Lanyard	PN 361	44mm wide Polyester Webbing	Steel Screw -Locking Karabiner PN 112	2 nos. of Steel Scaffold Hooks PN 131	
Energy Absorbing Forked Webbing Lanyard	PN 361(30)(A)	30mm wide Polyester Webbing	Steel Screw -Locking Karabiner PN 112	2 nos. of Aluminium Rebar Hooks PN 136	
Expandable Twin Lanyard	PN 371(A)	44 mm Tubular wide webbing	Steel Screw -Locking Karabiner PN 112	2 nos. of Aluminium Rebar Hooks PN 136	Relaxed length 1.4m, Expandable length 2.0m
Energy Absorbing Forked Kernmantle Rope Lanyard with jaws and Jed-I	JPN 341	11 mm dia Kernmantle Rope	Jed-I Hook PN 145	2 nos. of Jaws Hook PN 140	1.5m, 1.8m & 2.0 m
Energy Absorber Forked Twisted Rope Lanyard with jaws and Jed-I	JPN 351	12 mm dia 3 Strand Twisted Polyamide Rope	Jed-I Hook PN 145	2 nos. of Jaws Hook PN 140	

ANCHORAGES

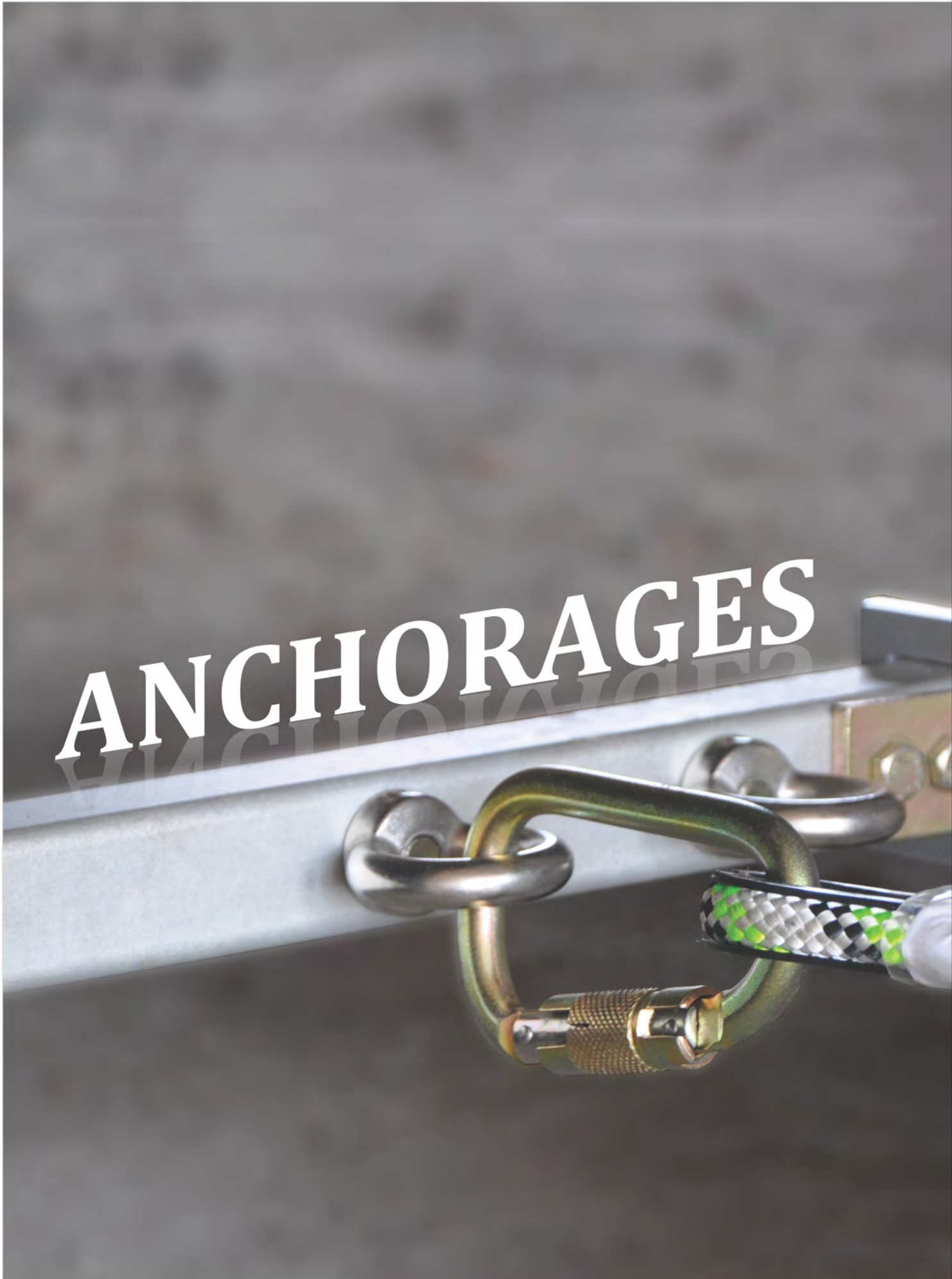



KARAM knows that finding a way to tie off is not always easy. KARAM offers a range of Anchorage devices which can be easily installed over a variety of structures to provide a safe anchorage points for working at height where needed.

KARAM Anchorage devices and connectors are thoroughly tested and engineered to adapt to nearly every anchorage need where connection of a fall arrest system to a 15kN anchor point is necessary. Whether you choose to tie off to your anchor point or an I-beam clamp, KARAM has the variety to get the job done.

KARAM offers a wide range of Anchorage Solutions in Webbing, Steel rope and Metal.

All these Anchorages Comply to the Latest European Standard EN 795:2012.



The Anchorage point is commonly referred to as a secure tie-off point. It is the place where a worker anchors himself so that he can easily move about that point, and also hold on safely in case he experiences a fall.

THERE ARE CERTAIN IMPORTANT POINTS TO NOTE WHILE ONE ANCHORS TO ANY ANCHORAGE POINT

1 Always make sure that the Anchorage used (whether a scaffolding bar, or the bar of a ladder, or an Anchorage Connector) is strong enough to hold you in case you are subjected to a fall. Technically, it should be capable of withstanding a static load of more than 15 kN for 3 minutes.

2 You should Anchor yourself to the point which lies either to your shoulder level, or higher than this. If the Anchorage point is below this, then the distance of the fall gets increased, thereby exposing you to a risk.

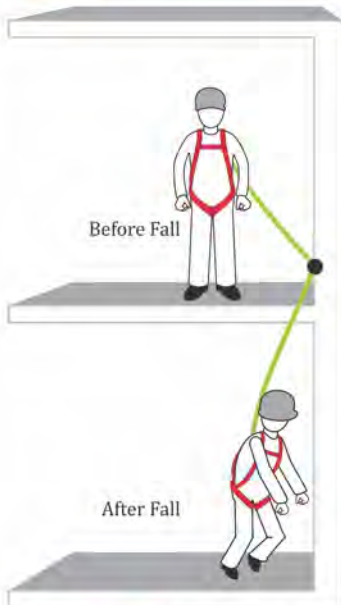

Fall when anchored at lower level

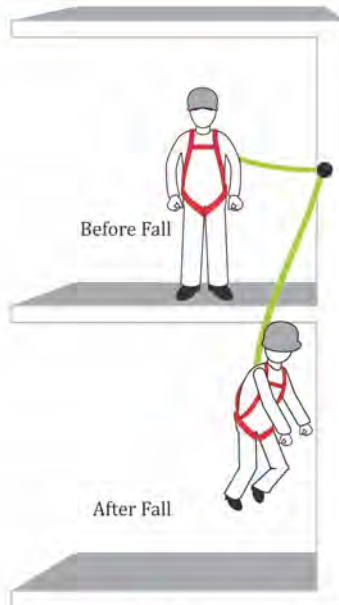

Fall when anchored on the side



Fall when anchored at a level above the head

3 **Avoid a Swing-Fall**
Try to anchor yourself to a point which is more vertically above you, than to your side. If the anchorage is on the side, you may experience a risky swing in the event of a fall, and may injure yourself by hitting an obstacle.

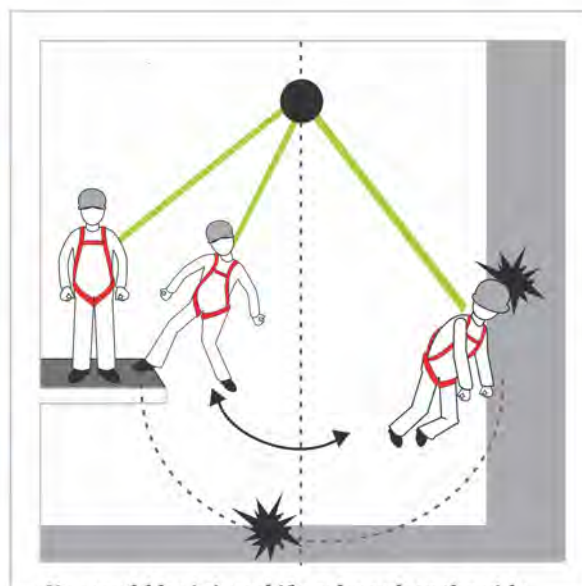

You could be injured if anchored on the side, due to the pendulum effect.



The
CHOSEN LOCATION
will determine the
ANCHORAGE POINT to use;
Here are some most Common Examples:



S. No.	Work Area	Hazard	Mobile Anchorage Solution	Fixed Anchorage Solution
1.	Ladder	<ul style="list-style-type: none"> ▶ Fall due to Vertical Climbing Up and Down 	Rope Grabs on flexible (textile) anchorage lines	<ul style="list-style-type: none"> ▶ FPS on Rigid Cable Line ▶ FPS on ALU Rail ▶ KARAM Ladder System- PN 9000
2.	Roof Top	<ul style="list-style-type: none"> ▶ Fall through Skylight ▶ Fall from Roof Edge ▶ Fall from Roof Slope 	Temporary Horizontal Line- PN 3000	Fixed Horizontal Line Systems- PN 4000, PN 5000
3.	Scaffold	<ul style="list-style-type: none"> ▶ Fall while Erecting and Dismantling the Scaffold ▶ Fall while working on Scaffold 	Retractable Twin Block Rope Grabs on Textile Anchorage Line	<ul style="list-style-type: none"> ▶ Retractable Twin Block ▶ FPS on ALU Rail ▶ KARAM Ladder System- PN 9000
4.	Truck Loading/ unloading	<ul style="list-style-type: none"> ▶ Fall from Truck; ▶ Injury due to Swing Fall 	NA	Fixed Horizontal Line Systems- PN 4000, PN 5000
5.	Beams and Griders	<ul style="list-style-type: none"> ▶ Fall due to movement on Beam 	Point Anchorage Devices- SA 08; SA 15; SA 13	
6.	Confined Spaces	<ul style="list-style-type: none"> ▶ Fall while lowering or raising the user 	Tripod	K-Pod
7.	Constructions	<ul style="list-style-type: none"> ▶ Fall through unguarded edges of Platforms/ Slabs 	Anchorage Slings & Point Anchorage Devices- PN 805; PN 806; SA 13A; SA 12; SA 09; SA 16	
8.	Tower Erection	<ul style="list-style-type: none"> ▶ Fall while Erecting and dismantling the Tower 	Retractable Twin Block	
9.	Exterior Facade	<ul style="list-style-type: none"> ▶ Fall while working in suspended position 	Parapet Anchor; SA 09; Point Anchorage Device SA 12	Floor Mounted Alu-Rail System; Floor Mounted Wire Rope System
10.	Rescue	<ul style="list-style-type: none"> ▶ Fall Hazard 	Anchorage Slings- PN 803; PN 807; PN 813	



Call **KARAM** Safety Expert
for further advise
Toll Free No.: 1800 103 7085

Anchorage Webbing Slings

KARAM provides a wide range of Anchorage Webbing Slings of various configurations and lengths that can be altered in length as per the requirement.

All Anchorages comply to the Latest European Standard
EN 795:2012

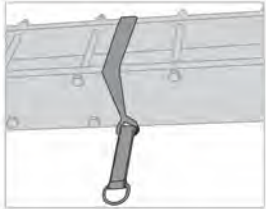

CE



Anchorage Webbing Sling Ref. PN 803

- ▶ Made up of 44mm wide Polyester Webbing.
- ▶ Length: 1.2mtr. or as requested.
- ▶ Has a D-Ring at one end and textile loop at the other end.
- ▶ Strength: Min 18 kN for 3 minutes.
- ▶ Conforms to EN 795 : 2012 Type B.



CE



Anchorage Webbing Sling Ref. PN 804

- ▶ Made up of 44mm wide Polyester Webbing.
- ▶ Length: 1.0mtr, 1.5mtr. & 2.0mtr. or as requested.
- ▶ Has a D-Ring on both the ends.
- ▶ Strength: Min 18 kN for 3 minutes.
- ▶ Conforms to EN 795 : 2012 Type B.

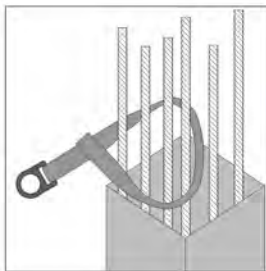

CE



Concrete Anchor Strap Ref. PN 805

- ▶ Made up of 44mm wide Polyester Webbing.
- ▶ Length: 1.07mtr. or as requested.
- ▶ Has a D-Ring at one end and textile loop at the other end, also provided with a polyester covering on the load-bearing face of the webbing.
- ▶ Strength: Min 18kN for 3 minutes.
- ▶ Conforms to EN 795:2012 Type B.

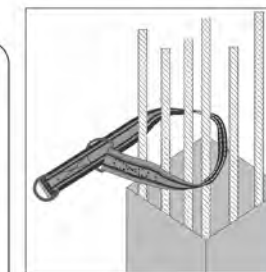

CE



Concrete Anchor Strap Ref. PN 806

- ▶ Made up of 44mm wide Polyester Webbing stitched with 70mm webbing at the back for extra protection.
- ▶ Length: 1.0mtr, 1.5mtr. & 2.0mtr. or as requested.
- ▶ Has a small D-ring on one end & a bigger D-ring on the other.
- ▶ Strength: Min 18kN for 3 minutes.
- ▶ Conforms to EN 795:2012 Type B.

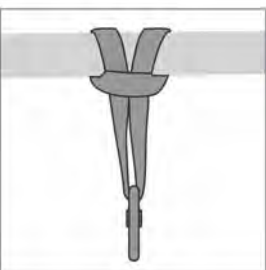

CE



Anchorage Webbing Sling Ref. PN 807(20)

- ▶ Made up of 20mm wide Polyester Webbing.
- ▶ Length: 0.6mtr, 1.0mtr. & 1.5mtr. or as requested.
- ▶ Strength: Min 18kN for 3 minutes.
- ▶ Conforms to EN 795:2012 Type B.

KARAM provides
ANCHORAGE WIRE ROPE SLINGS
 that can be used around edged
 structures, and are
 highly resistant to
 wear



CE

**Anchorage Steel Wire Rope Sling
 Ref. PN 813**

- ▶ Made of PVC coated 8.0mm G. I. Wire Rope. The PVC coating allows protection of anchorage surfaces.
- ▶ Available Length : 1.0mtr., 1.5mtr., 1.8mtr. & 2.0mtr. or as requested.
- ▶ Has Steel thimbles at both the ends to enable connection with all hardware.
- ▶ Minimum Breaking Strength : 23kN.
- ▶ Conforms to EN 795 : 2012 Type B.

Anchorage

KARAM offers a wide range of Point-Anchorage devices which provide a suitable Anchorage on a variety of base structures.

When using these point-anchorage, it is also important to ensure that the base surface meets the necessary strength requirement to hold the Anchorage device, and not get damaged in the event of exposure to an impact during a fall.



**Hinged Steel Roof Anchor
 Ref. SA 01**

The Hinged Steel Roof Anchor has hinged flaps which can be nailed to the roof wooden structure through various wide angles to provide a safe anchorage.

- ▶ Material: Galvanized Steel with stamped D-Ring
- ▶ Minimum Breaking Strength: 5000 lbs/22.5kN
- ▶ Finish: Powder Coated or Zinc Plated
- ▶ Net Weight: 1070.5 gms
- ▶ Conforms to: ANZIZ 359.12:2009



Call **KARAM** Safety Expert
 for further advise
 Toll Free No.: 1800 103 7085

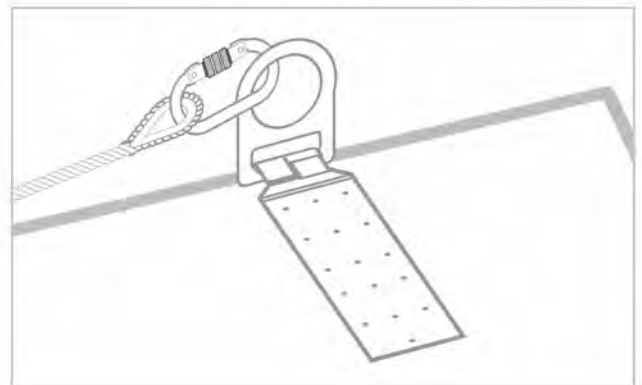

Beam Anchor

The Beam Anchor provides an anchorage point while being attached safely on to a Beam. **The Beam Anchor arm is adjustable, hence the device can be used on most Beams of width 90mm to 340mm (for SA 08) and 75mm to 150mm (for SA 08M).**

Once installed, the D-ring on the Aluminium bar of the Beam Anchor can be used for connection with a variety of connectors for suitable anchorage.

All Anchorages comply to the Latest European Standard
EN 795:2012



Technical Descriptions:

- ▶ Material : Aluminium Alloy & Brass. Highly corrosion resistant.
- ▶ Minimum Breaking (System Strength): 5000lbs/23kN.
- ▶ Net Weight : 1850gms ± 10gms.
- ▶ Flange width adjustable for SA 08 is 90mm to 340mm & for SA 08m is 75mm to 150mm.
- ▶ Conforms to EN 795:2012 Type B and ANSI Z 359.1-2007

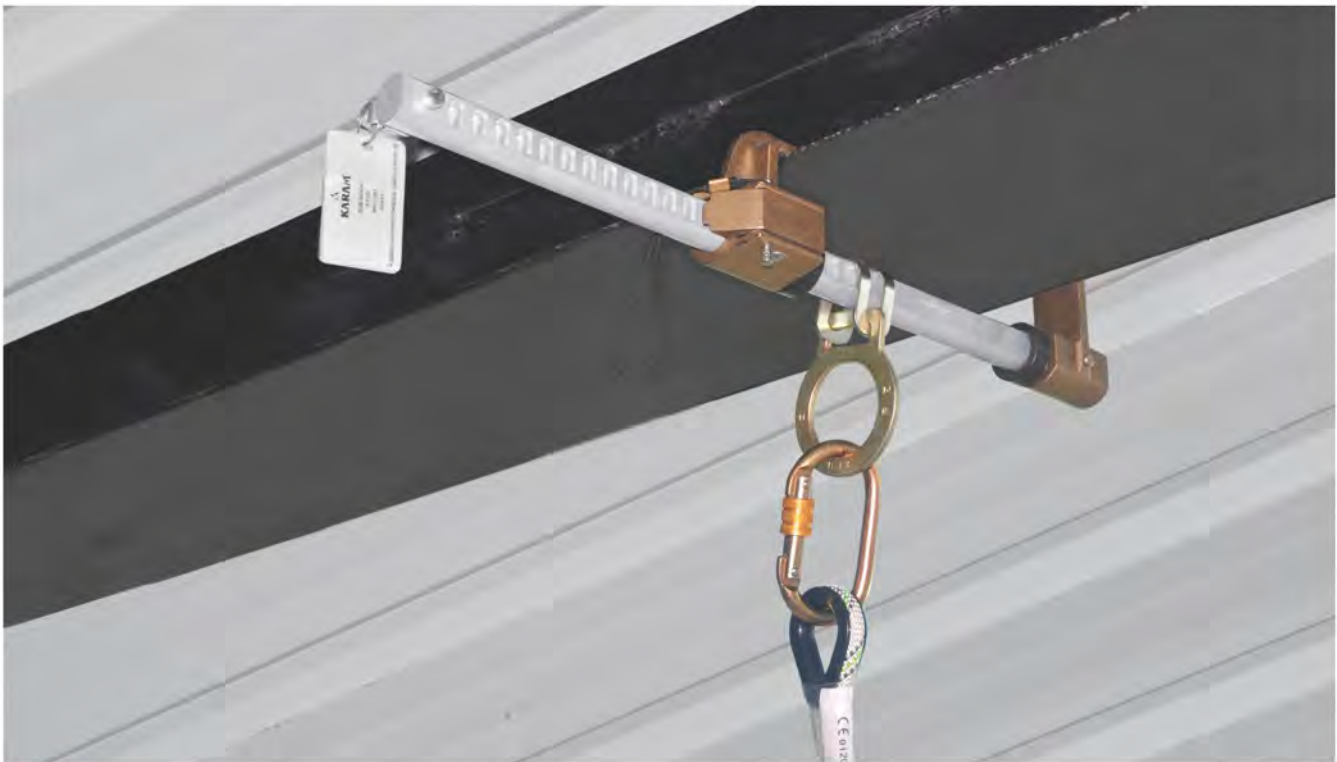

Call **KARAM** Safety Expert
for further advise
Toll Free No.: 1800 103 7085



Aluminium Point Anchor

All Anchorages comply to the Latest European Standard
EN 795:2012



Tested to withstand load from all the 3- axis

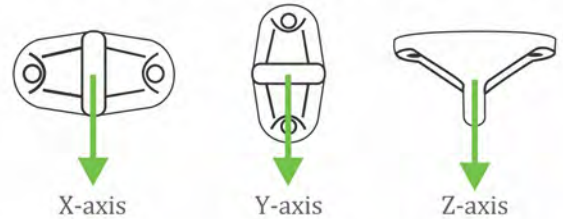

Ref. SA 09

This point-anchor is compact, made of aluminium alloy, highly corrosion resistant and can be bolted on any structure with the help of 2 screw-bolts. The anchorage provided by its eye-bolt has been tested to withstand the required load of 12 kN from all the 3 axis, and hence provides the highest level of safety.

Structures on which it can be mounted :

1. On Concrete structures having minimum width of 125mm.
2. Metal Structures using Metal Bolts.

Technical Description :

- ▶ Material : Aluminium Alloy.
- ▶ Minimum Breaking (System) Strength : 5000lbs/23kN.
- ▶ Finish : Natural Silver.
- ▶ Net Weight : 308gms.
- ▶ Conforms to EN 795 : 2012 Type A & ANSI Z 359.1 : 2007.

It is important to remove the anchorage point and send it for inspection once it has been subjected to a fall.



Call **KARAM** Safety Expert
for further advise
Toll Free No.: 1800 103 7085

All Anchorages comply to the Latest European Standard EN 795:2012

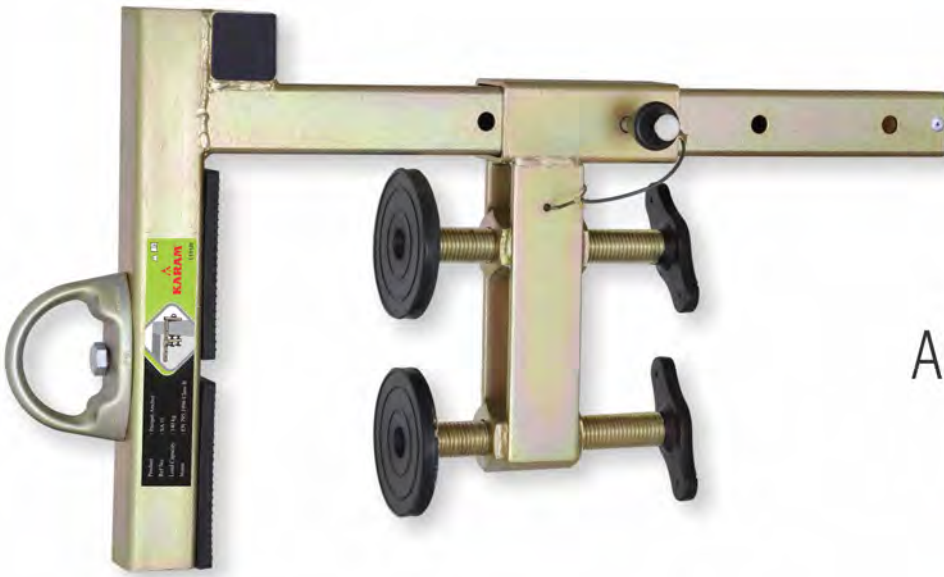

PROVIDES a safe ANCHORAGE POINT on PARAPETS and FACADES

PARAPET ANCHOR

Ref. SA 11

The KARAM Parapet Anchor provides a safe anchorage point on parapets and facades. A regular Screw-bolt anchor cannot be used in such places because it may damage the base structure.

KARAM Parapet Anchor preserves the look of the parapet and facade, while providing a safe anchorage point. The soft part on the inner of the Flanges also ensures that the parapet is not damaged.

The adjustable Flanges make the KARAM Parapet Anchor device versatile for use on various structures having a width ranging from 60mm to 360mm.

- ▶ Material: High strength steel galvanized to provide corrosion protection.
- ▶ Minimum Breaking (System) Strength: 5000lbs/23kN.
- ▶ Flange width adjustable from 60mm to 360mm.
- ▶ Net Weight : 8575gms.
- ▶ Conforms to EN 795 : 2012 Type B & ANSI Z 359.1:2007.

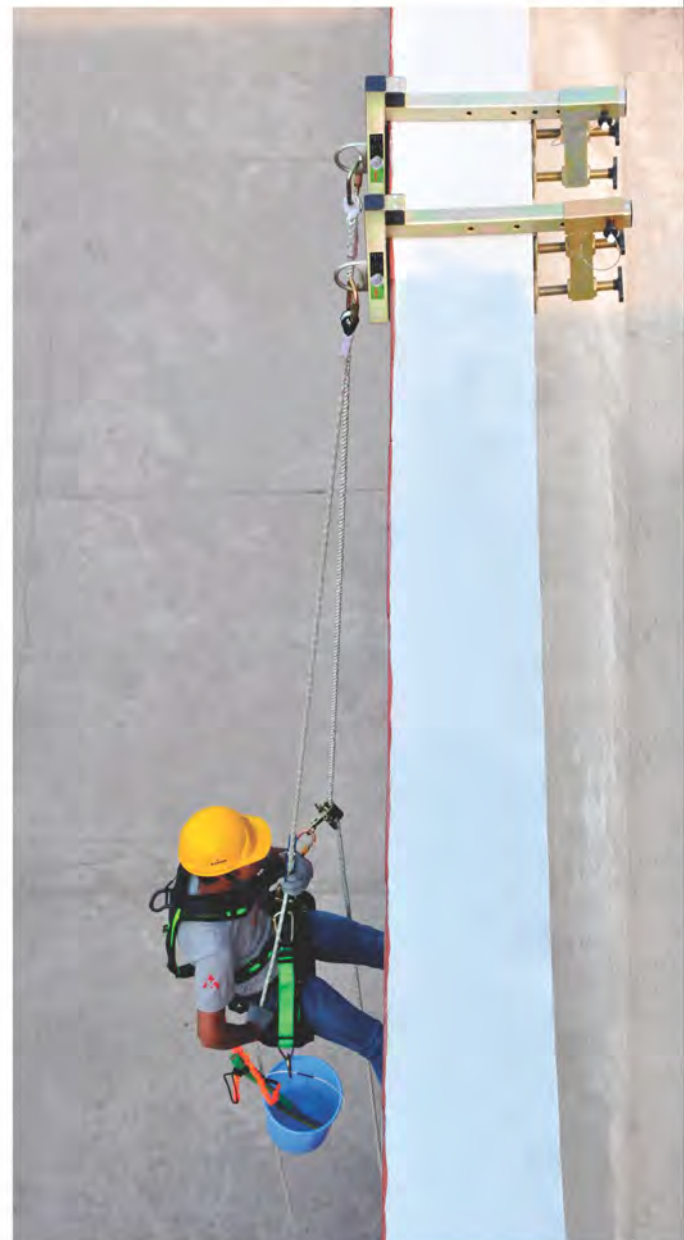

Call **KARAM** Safety Expert for further advise
Toll Free No.: 1800 103 7085

All Anchorages comply to the Latest European Standard
EN 795:2012

New



CE

ANSI

Steel Point Anchor Ref. SA 10A

This Forged steel Anchorage point is another device that can be bolted on any structure with the help of just a single screw-bolt.

- ▶ Material : Alloy Steel.
- ▶ Minimum Breaking (System) Strength : 5000lbs/23kN.
- ▶ Net Weight : 529±10gms.
- ▶ Conforms to EN 795 : 2012 & ANSIZ 359.1:2007.
- ▶ Process : Forged



CE

Stainless Steel Point Anchor Ref. SA 12

- ▶ For fastening into concrete.
- ▶ Material : Stainless Steel.
- ▶ Net Weight : 300 gm ± 10 gms.
- ▶ Conforms to : EN 795 : 2012 Type A.
- ▶ Is used with adhesive capsule Hilti 10 HVU M12 x 110.
- ▶ Drilling dia recommended for installation-14mm & Depth-110mm.



New

New

Girder Steel Anchor Ref. SA 13

CE ANSI

Concrete Steel Anchor Ref. SA 13 A

New



CE

ANSI

Steel Roof Anchor Ref. SA 14

- ▶ Material : Galvanized Steel.
- ▶ Minimum Breaking (System) Strength : 5000lbs/23kN.
- ▶ Net Weight : 465gms.
- ▶ Conforms to : EN 795 : 2012 & ANSIZ 359.1:2007.

Girder & Concrete Steel Anchor

- ▶ Material: Stainless steel and Alloy Steel
- ▶ Girder Steel Anchor SA13 can be installed on a steel structure having thickness upto 40mm through a hole of diameter ranging from 21mm to 30mm.
- ▶ Concrete Steel Anchor SA13A can be installed on steel structure & concrete wall having thickness upto 340mm by drilling a hole of dia 25mm
- ▶ Both these point anchors can be installed easily with one hand without use of any tools and fasteners
- ▶ Both the anchor points SA 13 and SA 13A are provided with green indicator band which becomes visible when the installation is complete to indicate fool-proof safety.
- ▶ Minimum Breaking (System) Strength: 5000 lbs. /25kN
- ▶ Net weight of Girder Steel Anchor: 550±10gms & Concrete Steel Anchor: 1250±10gms.
- ▶ Conforms to EN 795:2012 Type B & ANSIZ 359.1:2007



All Anchorages comply to the Latest European Standard EN 795:2012



Beam Anchor Trolley Ref. SA 15

KARAM introduces the New Beam-Anchor Trolley, which provides a movable anchorage point using the length of the Beam to which it is mounted, to move along with the user.

It is constructed of Aluminium and steel, is highly corrosion resistant, and extremely easy to install.

The Flanges are adjustable, and can be adjusted to widths from 80mm to 250mm.

The brass wheels of the trolley provide extremely smooth movement over the beam, over which it is mounted.

Anchorage is provided by a forged D-ring stitched to a webbing, attached to the trolley-bar.

- ▶ Minimum Breaking (System) Strength : 5000lbs/23kN.
- ▶ Net Weight : 4.155kgs±100gms.
- ▶ Conforms to : EN 795 : 2012 Type B & ANSI Z 359.1:2007.



Call **KARAM** Safety Expert for further advise
Toll Free No.: 1800 103 7085



Concrete Anchor Ref. SA 16

KARAM introduces an anchorage point which is extremely easy to install using a single hand, through a pre-defined hole of diameter 19mm, through a concrete wall which has a maximum thickness of 150mm.

The flanges are pulled in when the Eye of the anchor is pulled, allowing the anchor to pass through the hole. When the Eye is released, these flanges fan out along the outer part of the concrete wall, and hold the Anchor in its place.

- ▶ Material : Alloy Steel.
- ▶ Minimum Breaking (System) Strength: 5000 lbs/23kN.
- ▶ Net Weight : 150gm±10gm.
- ▶ Conforms to EN 795 : 2012 & ANSI Z 359.1:2007

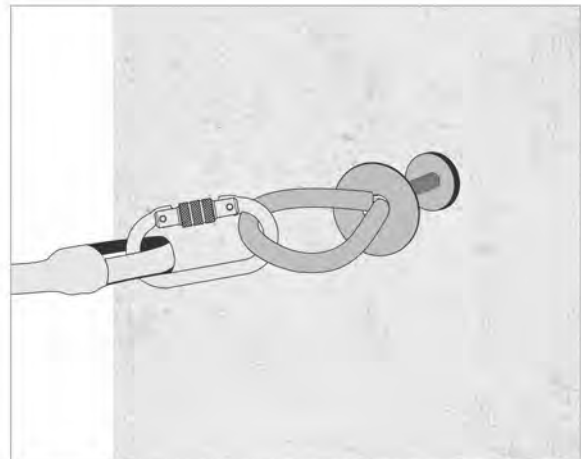

DOOR / WINDOW ANCHOR

Ref. PN 802

DOOR/WINDOW ANCHOR
A PERFECT NON-PENETRATING
ANCHORAGE SOLUTION

New



KARAM Advantage



KARAM Door Anchor is unique because it is provided with two separate eye bolts, enabling anchorage by two personnel at the same time.



Door Anchor Bag
Ref. BG 34



Door Anchor Ref. PN 802

The New KARAM Door Anchor provides a non-intrusive anchor point and can be easily installed inside the interior of a building or window opening enabling the most difficult jobs to get done safely and with confidence.

KARAM Door Anchor can be installed by just compressing it against the door or window frame, jamming itself between the two vertical sides.

It is constructed of Aluminium alloy, hence is highly corrosion resistant and is light in weight, **weighing less than 4.85 kg.**

The Arms of the KARAM Door Anchor are adjustable, enabling installation on door/window frames of width from 60 cm to 125 cm.

Fast and easy Installation with built in adjustment knob hence no tools or drilling is required.

Extremely portable design for easy transport, storage and usage.

- ▶ Minimum Breaking Strength : 13 kN
- ▶ Every Door Anchor is provided with Door Anchor Bag Ref. BG 34
- ▶ Conforms to EN 795: 2002 Type B & ANSI Z 359.1:2007

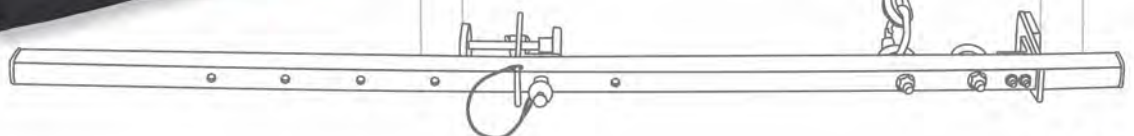



TELESCOPIC POLE SYSTEM

TELESCOPIC POLE is a perfect solution to create overhead anchors at UNREACHABLE HEIGHTS.

Telescopic Pole Ref. PN 815(04)

- ▶ Material : Fiberglass.
- ▶ Maximum Length : 7.95 m.
- ▶ Minimum Length : 1.95 m.
- ▶ Weight : 3800 gms.



Hanging Hook Ref. PN 815(03)

- ▶ Material : Alloy Steel, Plastic Moulded.
- ▶ Weight : 190 gms.

KARAM Telescopic Pole is light in weight, made up of fibre glass, and can be effectively used to install an anchorage point from a distance.

Features :

- The Total weight of the Telescopic Pole assembly without the hook is approx. 4.6kg, and hence can be easily carried.
- Working reach with Extension : 10.5m (This includes 8.95m of fully expanded length of the pole extension and 1.55m of user's height).
- Open Expanded Height of Telescopic Pole : 7.95m. Closed Length of Telescopic Pole : 1.95m
- Voltage Rating : 30KV
- Comes with an option of using either the Steel Anchorage hook PN 156, or the Aluminium Anchorage hook PN 154, to Anchor at the required distance.



Extension Section Ref. PN 815(02)

- ▶ Length : 1 m.
- ▶ Weight : 425 gms.



Head Ref. PN 815(01)

- ▶ Length : 240 cm.
- ▶ Weight : 185 gms.



Aluminium Anchorage Hook Ref. PN 154

- ▶ Material : Aluminium Alloy.
- ▶ Opening : 60 mm.
- ▶ Minimum Breaking Strength : 23kN.
- ▶ Weight : 480 gms.
- ▶ Conforms : EN 362:2004 Class A & EN 795:2012 Type B.



Steel Anchorage Hook Ref. PN 156

- ▶ Material : Alloy Steel.
- ▶ Opening : 95 mm.
- ▶ Minimum Breaking Strength : 23kN.
- ▶ Finish : Silver/Golden Yellow Galvanized; Shot blasted on request.
- ▶ Weight : 880 gms.
- ▶ Conforms : EN 795:2012 Type B.

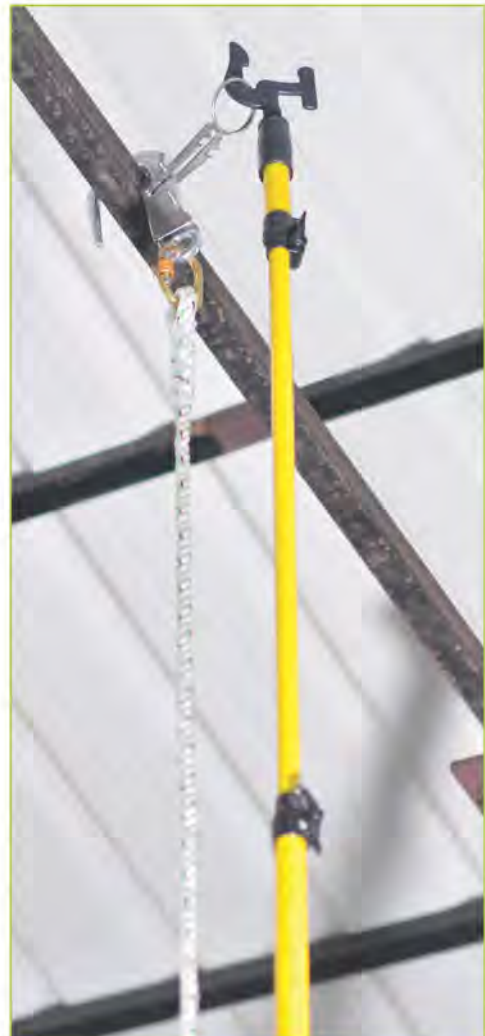

Click on <http://karam.in/videos/> to know more, or scan the QR code alongside





Temporary Horizontal Anchorage Line Ref. Horizon PN 3000

KARAM introduces the HORIZON range of Horizontal Anchorage Lifeline, to provide a suitable and safe anchorage extending horizontally along a length.



Ref. Horizon PN 3000

- ▶ The Horizon- PN 3000 is a Horizontal Anchorage Life Line made up of 30 mm Polyester Webbing equipped with the KARAM Ratchet Tensioner that allows easy tensioning of the lifeline between two supports. Both the ends are provided with Auto Locking Steel Karabiners (Our Ref PN 113)
- ▶ The whole system is supplied in a bag, which is permanently attached to the assembly and also enables the user to easily carry the system with the help of comfortable shoulder hanging straps provided in the bag.
- ▶ Once fitted, you can easily put back the extra webbing not deployed along the length, into the Bag.
- ▶ Conforms to EN 795 Class B
- ▶ Available Length- Total 20m, thus the user can use it for a length ranging from 5m to 20m.
- ▶ Tested & Certified for use by Two Users simultaneously.

Once the Lifeline is fitted, the user can easily attach the Lanyard of his Harness to the Lifeline using a Karabiner. This allows movement along the length while keeping the user secured and safe at all times.

Be Careful !

When installing the lifeline it is essential to take into account the deflection (f) of the lifeline that need to be add to the clearance of the fall arrest system used.

$$f = 2 \text{ m (for } L=20\text{m)}$$

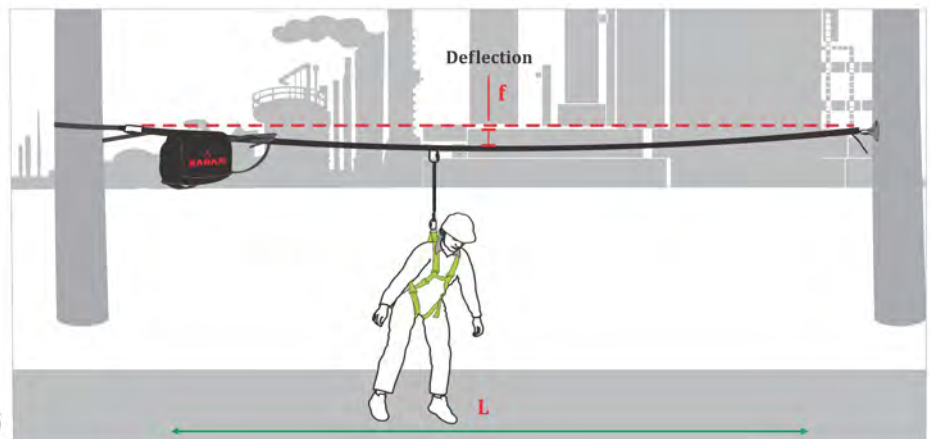

Call **KARAM** Safety Expert
for further advise
Toll Free No.: 1800 103 7085





KARAM Rope Grab Fall Arrestors have a wide application of usage in fall arrest while climbing, and in restraint while working on roof tops, platforms and inclined planes.

In the event of a fall, they are designed to “grab” on to the Anchorage Line on which they move, thus arresting the fall immediately.

The Anchorage line, in conjunction with the given Rope Grab provides the necessary Shock Absorption.

Rope Grab Fall Arresters



KARAM Rope Grab PN 2000



KARAM Rope Grab PN 2000 is a detachable Rope Grab Device, made up of high strength steel.

It moves freely along the polyamide twisted rope anchorage line (14mm to 16mm dia), attached at its eye with the user, while he moves up and down.

The rope grab immediately 'grabs' on to the line in the event of a fall, thereby arresting the fall.

Conforms to EN 353-2:2002



Ref. PN 2000 A

- ▶ Fall Arrester with Karabiner
- ▶ Steel Karabiner PN 112 as an attachment element.



Ref. PN 2000 B

- ▶ Fall Arrester with Energy Absorber
- ▶ Energy Absorber PN 300 and Steel Karabiner PN 112 as an attachment element.



Ref. PN 2000 C

- ▶ Fall Arrester with Spacing Absorber
- ▶ Spacing Strap and hook PN 121 as an attachment element.



KARAM ADVANTAGE

Allows the user to go up but not slide down accidentally.
Keeps in stationary position when locked.

KARAM Rope Grab is provided with a unique Gravity Locking system that prevents incorrect usage. It is also equipped with a double security opening system, and hence will not open unless a deliberate action taken.



Automatic Locking



Locked position allows Manual Locking



Only KARAM Fall Arrester comes with the unique Anti-Gravity Locking System.



Non-Detachable Steel Fall Arrester on Kernmantle Rope Anchorage Line Ref. PN 2003

This Fall Arrester, constructed of high strength steel works on 12mm dia Kernmantle rope anchorage line incorporated permanently on the anchorage line, and comes with an energy absorbing element.

This gives an advantage that the worker does not lose the device when the equipment is not in use.

This rope grab is an ideal Fall Restraint device for use while working on platforms and roofs.

- ▶ The Anchorage line has one side loop for connector and the other side a stop knot.
- ▶ The Anchorage line is available in lengths of 5m to 100m
- ▶ Conforms to EN 353-2:2002.

New



Non-Detachable Stainless Steel Fall Arrester on Kernmantle Rope Anchorage Line Ref. PN 2004

This Rope Grab is constructed of Stainless Steel, hence is highly Corrosion Resistant, hence suitable for marine & off shore atmosphere.

It is non detachable from the rope - so it will always be there on the rope when you look for it.

- ▶ This Fall Arrester works on 12mm dia Kernmantle rope anchorage line incorporated permanently on the anchorage line, and comes with an energy absorbing element.
- ▶ The Anchorage line has one side loop for connector and the other side a stop knot.
- ▶ The Anchorage line is available in lengths of 5m to 100m
- ▶ Conforms to EN 353-2:2002.



Detachable Stainless Steel Fall Arrester on Kernmantle Rope Anchorage Line Ref. PN 2005; PN 2005 (AP)

- ▶ Works on 12mm dia kernmantle rope anchorage line, without any manual intervention.
- ▶ Consists of openable rope grab hence can be easily detached from the anchorage line.
- ▶ It is made of stainless steel, hence is highly corrosion resistant.
- ▶ It has a manual lock position to allow work on inclined roof
- ▶ **PN 2005 (AP) is provided with a stainless steel openable rope grab with unique anti-panic feature.**
- ▶ The anchorage line has one side loop for connector PN 112 and other side a stop knot. The termination is cross-stitched, and is protected with a strong transparent covering sleeve which not only protects the end but also makes the stitches visible for easy inspection prior to use.
- ▶ Abrasion resistant thimble to protect the loops from being damaged by metallic contact.
- ▶ Coloured tracer strand which loses its colour in due course of time, to show that the rope is now unfit for further use.
- ▶ The anchorage line available in lengths of 5mtrs to 100 mtrs.
- ▶ Conforms to EN 353-2:2002.

What Is Anti Panic

Rope Grabs are designed to allow uninhibited and unhindered movement while ascending or descending a rope life line. This is possible because there mechanism features a cam which releases during normal use.

When the fall occurs this clamp closes to a grab position onto the rope lifeline, hence immediately arresting the fall.

However, a user, in most situations, comes under a state of panic when experiencing a fall. He immediately reaches out to grasp the rope grab, thereby releasing the cam and preventing the device from grabbing onto to Rope. In such a case, the rope grab fails in its purpose and a fall is induced by the panic stricken user

KARAM introduces an ANTI PANIC Locking feature in its new Rope Grab System in PN 2005 & PN 2007 which helps to keep the Rope Grab securely anchored to the life line even when the user grips the device.

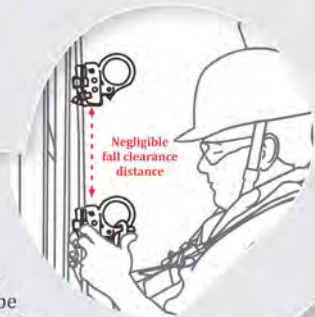



Detachable Aluminium Fall Arrester on Kernmantle Rope Anchorage Line

Ref. PN2006

This Rope grab is Openable, and is constructed of high strength Aluminium Alloy, which is extremely light in weight, and is highly corrosion resistant.

- ▶ Works on 12mm dia kernmantle rope anchorage line, without any manual intervention.
- ▶ Has a manual lock position to allow work on inclined roof, and also restraint positioning.
- ▶ The Anchorage line is provided in lengths of 5mtrs to 100mtrs, **incorporated with energy absorber at the anchorage end** and a stop knot at the other end. This Energy Absorber ensures that the line absorbs the impact in the event of a fall.
- ▶ Abrasion resistant thimble to protect the loops from being damaged by metallic contact.
- ▶ The termination is cross-stitched, and is protected with a strong transparent covering sleeve which not only protects the end but also makes the stitches visible for easy inspection prior to use.
- ▶ Coloured tracer strand which loses its colour in due course of time, to show that the rope is now unfit for further use
- ▶ Conforms to EN 353-2:2002.



Call **KARAM** Safety Expert
for further advise
Toll Free No.: 1800 103 7085



New

With Anti Panic Feature

Dia of Eye 25mm

New

Dia of Eye 50mm

CE
PN 2007

CE
PN 2007 (AP)



Detachable Galvanized Steel Fall Arrester on Twisted Rope Anchorage Line Ref. PN 2007; PN 2007 (AP)

- ▶ Works on 14mm to 16mm dia polyamide twisted rope anchorage line, without any manual intervention.
- ▶ **Consists of openable rope grab made of galvanized steel.**
- ▶ Has a manual lock position to allow work on inclined roof.
- ▶ **PN 2007 (AP) is provided with a galvanized steel openable rope grab with unique anti-panic feature.**
- ▶ The anchorage line has one side loop for connector PN 112 and other side a stop knot. The termination is spliced and is protected with a strong transparent covering sleeve which not only protects the end but also makes the splicing visible for easy inspection prior to use.
- ▶ Abrasion resistant thimble to protect the loops from being damaged by metallic contact.
- ▶ Coloured tracer strand which loses its colour in due course of time, to show that the rope is now unfit for further use.
- ▶ The anchorage line available in lengths of 5mtrs to 100 mtrs.
- ▶ Conforms to EN 353-2:2002



Call **KARAM** Safety Expert
for further advise
Toll Free No.: 1800 103 7085



Twisted Rope Anchorage Line (to be used with KARAM Fall Arrester)

- ▶ Made of 3-Strand polyamide twisted rope of dia 14 mm
- ▶ One side loop; other side end stop knot
(Also Available with Both Side Loops)
- ▶ Length - 10m Ref. Anchor PN 910
- 20m Ref. Anchor PN 920
- 30m Ref. Anchor PN 930
- 40m Ref. Anchor PN 940
- 50m Ref. Anchor PN 950
- 100m Ref. Anchor PN 9100
- 150m Ref. Anchor PN 9150
- 200m Ref. Anchor PN 9200
- ▶ Longer lengths are also available on request



Kernmantle Rope Anchorage Line (to be used with KARAM Fall Arrester)

- ▶ Made of Kernmantle rope of dia 12 mm
- ▶ One side loop; other side end stop knot
(Also Available with Both Side Loops)
- ▶ Length - 10m Ref. Anchor PN 910 (K)
- 20m Ref. Anchor PN 920 (K)
- 30m Ref. Anchor PN 930 (K)
- 40m Ref. Anchor PN 940 (K)
- 50m Ref. Anchor PN 950 (K)
- ▶ Longer lengths are also available on request

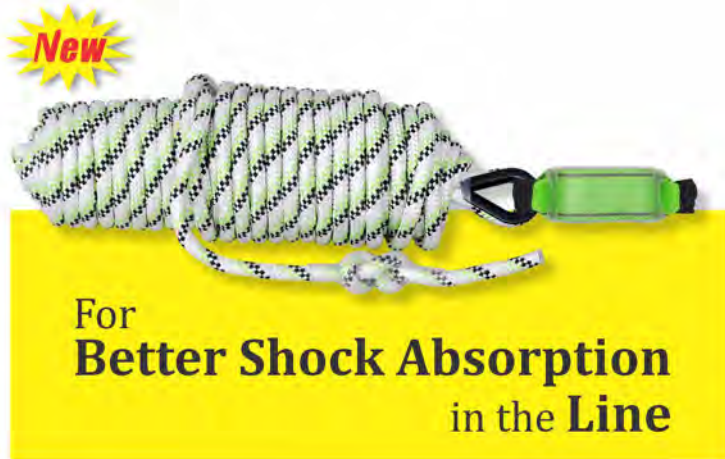

Kernmantle Rope Anchorage Line with Energy Absorber (to be used with KARAM Fall Arrester) at anchorage end

- ▶ Made of polyamide rope of dia 12 mm
- ▶ One side loop; other side end stop knot
(Also Available with Both Side Loops)
- ▶ Length - 10m Ref. Anchor PN 910 (KS)
- 20m Ref. Anchor PN 920 (KS)
- 30m Ref. Anchor PN 930 (KS)
- 40m Ref. Anchor PN 940 (KS)
- 50m Ref. Anchor PN 950 (KS)
- ▶ Longer lengths are also available on request



Openable Protective Sleeve Ref. PR 02

- ▶ Designed to protect flexible Anchorage Lines against abrasion due to friction.
- ▶ Is made of flexible PVC and is detachable.
- ▶ The Width of PR 02 is:
Open : 130mm
Folder : 50mm
- ▶ Can be opened/closed with the help of Velcro tape stitched along its length.
- ▶ Standard length : 55cm.





Call **KARAM** Safety Expert
for further advise
Toll Free No.: 1800 103 7085

KARAM provides a vast range of Permanent Horizontal & Vertical Anchorage Lines, Conforming to EN 795 Type C. These systems are corrosion resistant and can be fixed on various structures to provide safe anchorage for extended period of time.

Fixed Line Systems (Vertical & Horizontal)



Vertical Anchorage Line System on Rigid Cable Line

Ref. VERTEX PN 7000

EN 353-1:2012



FALL PROTECTION FOR

- ▶ Industrial Ladders
- ▶ Chimney Ladders
- ▶ Telecommunication Towers
- ▶ Power Transmission Towers
- ▶ Windmill

FEATURE & BENEFITS

- ▶ MOC: Stainless Steel Grade 316
- ▶ Shock absorber reduces impact of fall on victim as well as receiving structure.
- ▶ suitable for 1 person
- ▶ intermediates to reduce vibrations due to wind pressure at every 10 mtrs
- ▶ Trained Installers and Engineers to install the system.

Recommended PPE

- ▶ Full Body Harness
Ref. PN 56
- ▶ Forked Lanyard
Ref. PN 351
- ▶ Work Positioning
PN 242

Click on <http://karam.in/videos/> to know more, or scan the QR code alongside

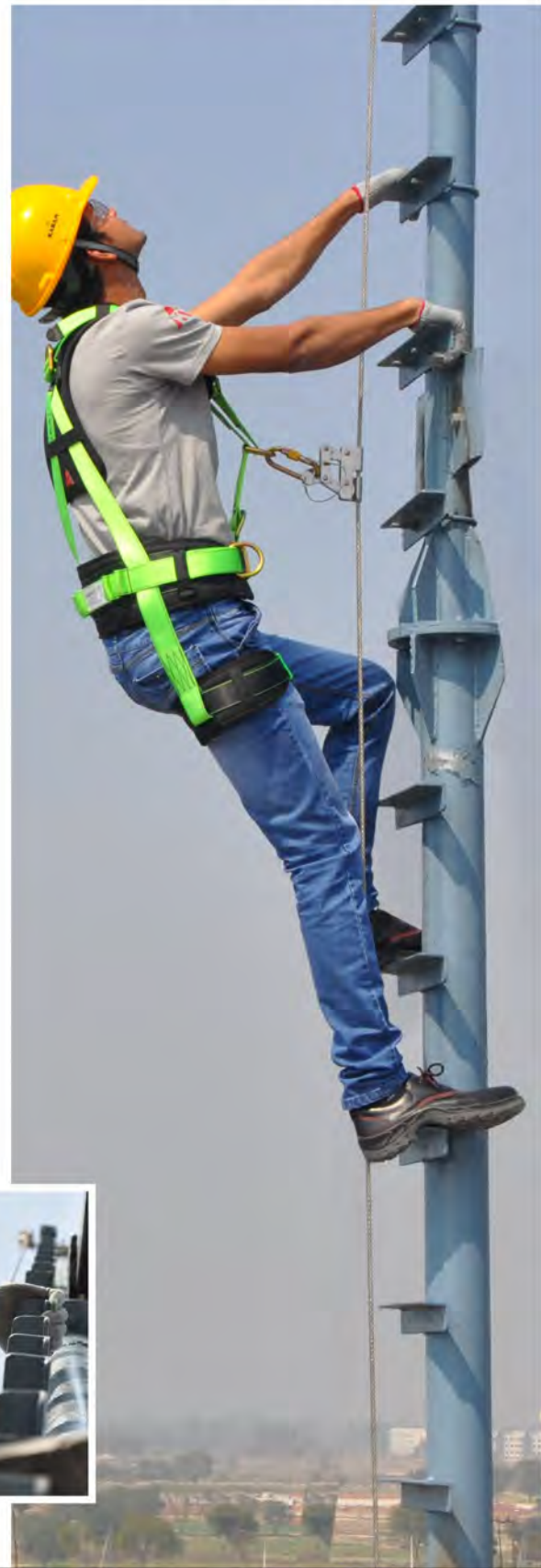



Ref. VERTEX PN 7000

**Shock Absorber
Ref. PN 7000 (02)**

- ▶ Material : Stainless Steel 316.
- ▶ Limits the impact of force in the event of fall to less than 6kN.
- ▶ Quantity : 1 nos.



**Mounting Bracket
Ref. PN 7000 (01)**

- ▶ Material : Stainless Steel 316.
- ▶ Breaking Strength > 23kN.
- ▶ Complies with EN 795 Class A1.
- ▶ Quantity : 2 nos.

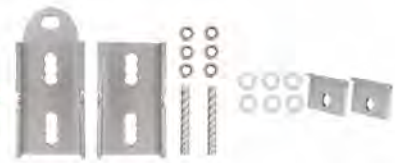

Wire Rope (with one end having a swaged loops)

Ref. PN 9XXXSL (Where XXX is the length of the wire rope in meters)

- ▶ Material : Stainless Steel 316.
- ▶ Diameter : 8mm.
- ▶ Construction : 7x19.



7 STRANDS OF
19 WIRES

**Rope Grab
Ref. RG-02 112**

- ▶ Material : Stainless Steel 316.
- ▶ Works on stainless steel wire rope.
- ▶ Quantity : 1 nos.

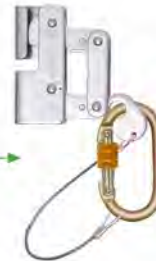

**Wire Rope Cap
Ref. PN 7000 (12)**

- ▶ Material : Aluminium Alloy.
- ▶ Quantity : 2 nos.



**Intermediate
Ref. PN 2001 (04)**

- ▶ Material : Stainless Steel 316.
- ▶ Recommended Installation-Every 10m.



**Set of U-bolts and Thimbles
Ref. PN 6000 (01)**

- ▶ U-Bolts : Qty-2 nos.
- ▶ Material : Stainless Steel 316.
- ▶ Thimbles : Qty-1 nos.
- ▶ Material : Galvanized Steel.
- ▶ Quantity : 1 set.



**Tensioner
Ref. PN 7000 (05)**

- ▶ Regulates tensioning of the cable.
- ▶ Material : Stainless Steel 316.
- ▶ Quantity : 1 nos.

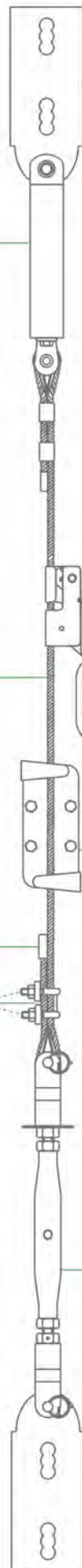



Vertical Anchorage Line System on Rigid Aluminium Rail System

Ref. VERTEX PN 8000

EN 353-1:2012

FALL PROTECTION FOR

- ▶ Out door Ladders
- ▶ Chimneys
- ▶ Wind Energy
- ▶ Transmission Lines
- ▶ Advertizement Bill Boards

FEATURE & BENEFITS

- ▶ Continuous ladder with Fall Protection
- ▶ Can negotiate bends
- ▶ Corrosion free anodized aluminum rail
- ▶ Hot dipped galvanized rugs
- ▶ Four wheel trolley slides on the rail and locks in an event of a fall
- ▶ Assists in climbing. The unique design of trolley supports the user while ascent or descent
- ▶ Locking jibs at either end for unintentional release of trolley from the rail while in use
- ▶ Alu. Rail extension to safely remove the trolley after reaching the landing platform.

Recommended PPE

- ▶ Full Body Harness
Ref. PN 56
- ▶ Forked Lanyard
Ref. PN 351
- ▶ Work Positioning
PN 242





Ref. VERTEX PN 8000

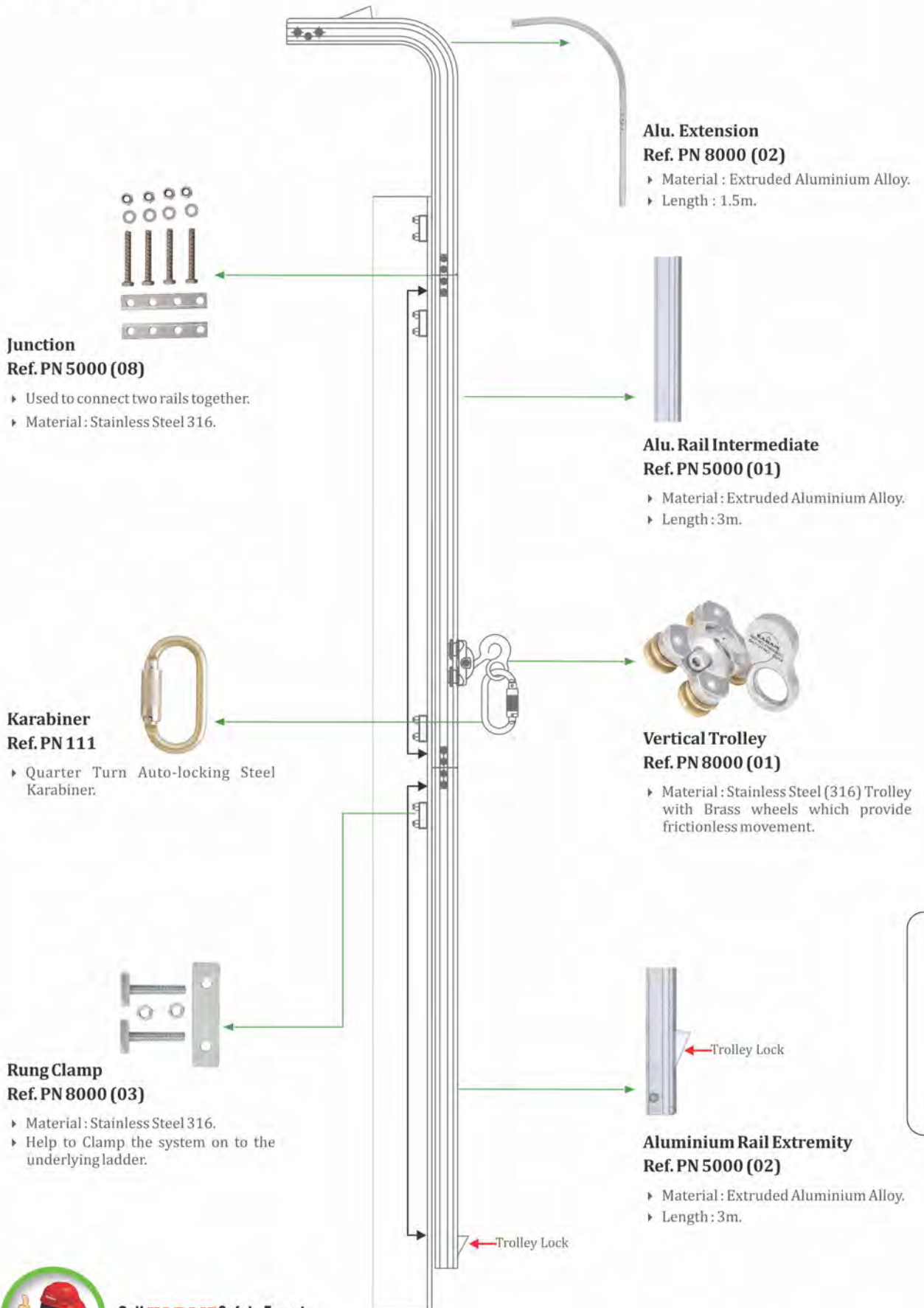

Call **KARAM** Safety Expert
for further advise
Toll Free No.: 1800 103 7085



Vertical Anchorage Line System on Rigid Aluminium Rail System

Ref. VERTEX PN 9000

EN 353-1:2012

FALL PROTECTION FOR

- ▶ Out door Ladders
- ▶ Chimneys
- ▶ Wind Energy
- ▶ Transmission Lines
- ▶ Advertizement Bill Boards

FEATURE & BENEFITS

- ▶ Continuous ladder with Fall Protection
- ▶ Can negotiate bends
- ▶ Corrosion free anodized aluminum rail
- ▶ Hot dipped galvanized rugs
- ▶ Four wheel trolley slides on the rail and locks in an event of a fall
- ▶ Assists in climbing. The unique design of trolley supports the user while ascent or descent
- ▶ Locking jibs at either end for unintentional release of trolley from the rail while in use
- ▶ Alu. Rail extension to safely remove the trolley after reaching the landing platform.

Recommended PPE

- ▶ Full Body Harness
Ref. PN 56
- ▶ Forked Lanyard
Ref. PN 351
- ▶ Work Positioning
PN 242

Click on <http://karam.in/videos/> to know more, or scan the QR code alongside





Ref. VERTEX PN 9000

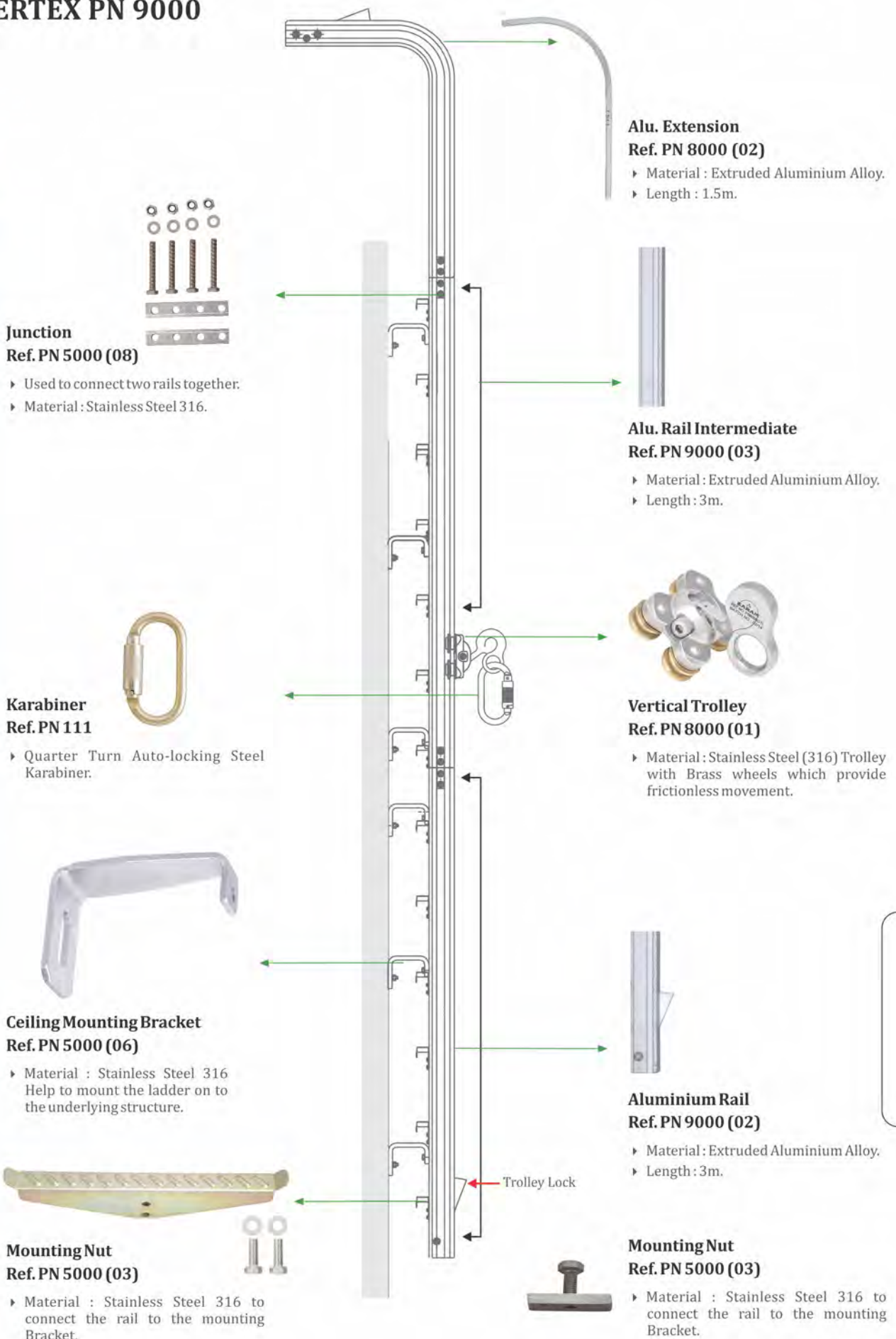



Horizontal Anchorage Line System on Rigid Cable Line Ref. HORIZON PN 4000 (Over the Roof)



EN 795 TYPE C

FALL PROTECTION FOR

- ▶ Pre-engineered Building Roofs
- ▶ Fragile Roofs
- ▶ Air ports

FEATURE & BENEFITS

- ▶ MOC : Stainless Steel Grade 316
- ▶ Maximum Number of users : 4
- ▶ System length : As per requirement
- ▶ Number of PPE Recommended : As per requirement
- ▶ Carriage body passes through intermediates without disconnection
- ▶ Shock absorber reduces impact of fall on victim as well as receiving structure.
- ▶ The Shock Absorber features a tension indicator and a fall indicator.
- ▶ Special waterproof posts fitted to roofsheets by blind rivets.
- ▶ Trained Installers and Engineers to install the system.

Intermediate Brackets Orientation for different Installations

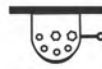

Ceiling Mounting



Floor Mounting

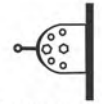

Wall Mounting

Recommended PPE

- ▶ Full Body Harness
Ref. PN 56
- ▶ Guided Type Fall Arrester on Flexible Anchorage Line
Ref. PN 2003

Click on <http://karam.in/videos/> to know more, or scan the QR code alongside



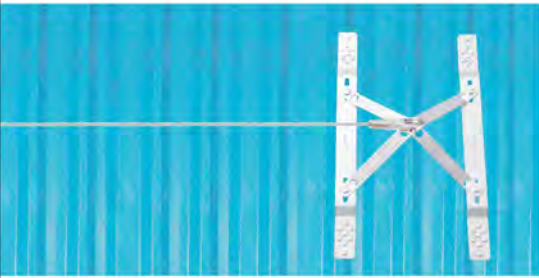

Ref. HORIZON PN 4000 (Over the Roof)

Roof Top Anchor Port
Intermediate
Ref. PN 07 (B)

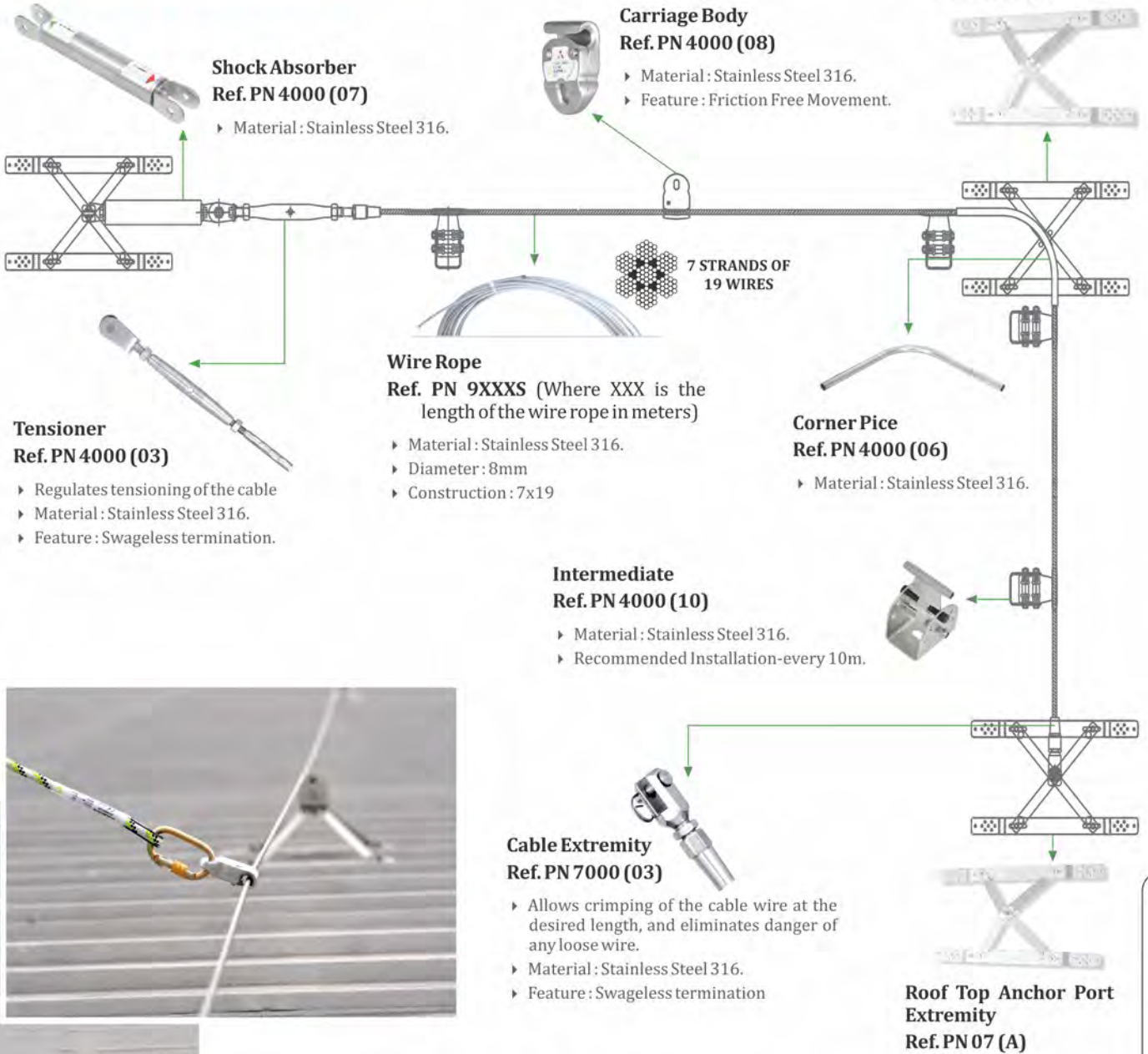

For Galvalume Sheet



Roof Top Anchor Post
Extremity
Ref. SA 07 A



Roof Top Anchor Post
Intermediate
Ref. SA 07 B

For Standing Seam Sheet

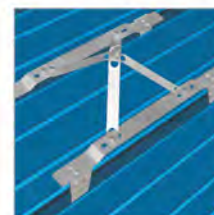

Roof Top Anchor Post
Extremity
Ref. SA 07 C



Roof Top Anchor Post
Intermediate
Ref. SA 07 D



Horizontal Anchorage Line System on Rigid Cable Line Ref. HORIZON PN 4000 (Over the Head)



EN 795 TYPE C

FALL PROTECTION FOR

- ▶ Truck Loading / unloading
- ▶ Advertisement Bill Boards
- ▶ Industrial Cranes
- ▶ Oversized machines, Reactors, Turbines etc.

FEATURE & BENEFITS

- ▶ Made of Stainless Steel Grade 316
- ▶ Single Span System.
- ▶ System length : 10 meters.
- ▶ Number of PPE Recommended : 1 set.
- ▶ Equipped with a Shock absorber which reduces impact of fall on victim as well as receiving structure.
- ▶ ATEX approved systems for use in potentially explosive areas.
- ▶ Trained Installers and Engineers to install the system.

Recommended PPE

- ▶ No Spark Antistatic Full Body Harness
Ref. PN 22 (AS)
- ▶ Retractable Fall Arrester
Ref. PCGS 05



Call **KARAM** Safety Expert
for further advise
Toll Free No.: 1800 103 7085

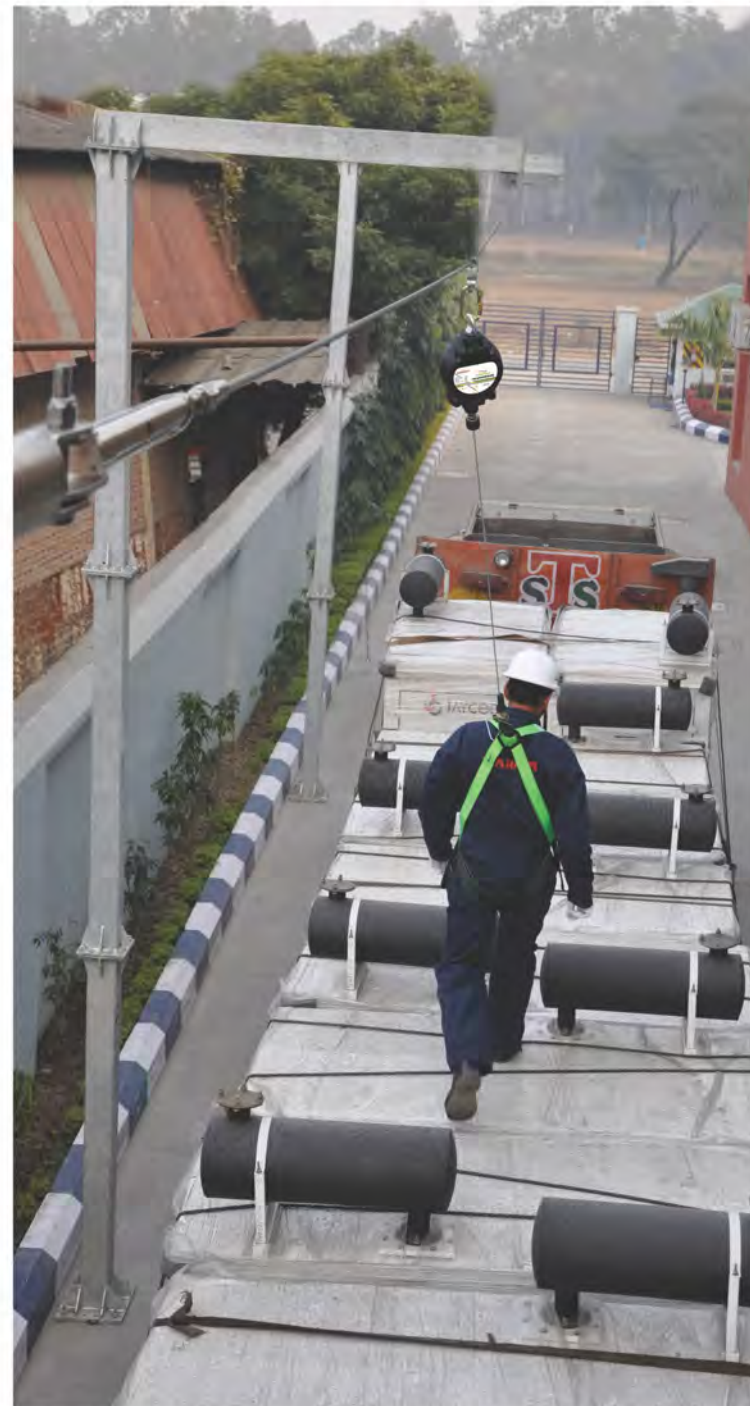



Ref. HORIZON PN 4000 (Over the Head)



Universal Extremity Plate Ref. PN 4000 (09)

- ▶ Material : Stainless Steel 316



Carriage Body Ref. PN 4000 (08)

- ▶ Material : Stainless Steel 316.
- ▶ Feature : Friction Free Movement.



Wire Rope

Ref. PN 9XXXS (Where XXX is the length of the wire rope in meters)

- ▶ Material : Stainless Steel 316.
- ▶ Diameter : 8mm
- ▶ Construction : 7x19



Shock Absorber Ref. PN 4000 (07)

- ▶ Material : Stainless Steel 316.



Cable Extremity Ref. PN 7000 (03)

- ▶ Allows crimping of the cable wire at the desired length, and eliminates danger of any loose wire.
- ▶ Material : Stainless Steel 316.
- ▶ Feature : Swageless termination



Intermediate Ref. PN 4000 (10)

- ▶ Material : Stainless Steel 316.
- ▶ Recommended Installation-every 10m.



Tensioner Ref. PN 4000 (03)

- ▶ Regulates tensioning of the cable
- ▶ Material : Stainless Steel 316.
- ▶ Feature : Swageless termination.

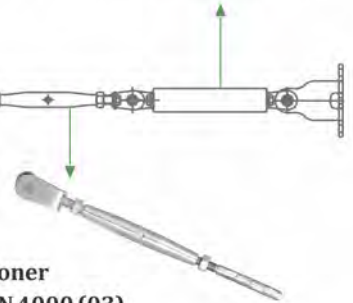



Horizontal Anchorage Line System on Rigid Aluminium Rail Ref. HORIZON PN 5000



EN 795 TYPE D

FALL PROTECTION FOR

- ▶ Parapets
- ▶ Window Cleaning
- ▶ Wind mills and Nacellec
- ▶ Domes
- ▶ Machines top with unguarded edges

FEATURE & BENEFITS

- ▶ Continuous movement with complete fall protection
- ▶ Corrosion free anodized Aluminum rail.
- ▶ Four wheel trolley slides on the rail provides restrain against fall.
- ▶ Locking jibs at either end for unintentional removal of trolley while in use.
- ▶ Curved aluminum rail for easy movement.

Recommended PPE

- ▶ Full Body Harness
Ref. PN 56
- ▶ Restraint Lanyard
Ref. PN 2003



Call **KARAM** Safety Expert
for further advise
Toll Free No.: 1800 103 7085

Installations Using Different Types of Mounting Brackets



Wall Mounted Installation
(with Recess)



Wall Mounted Installation
(Flush Type)



Floor Mounted Installation



Ceiling Mounted Installation





Ref. HORIZON PN 5000

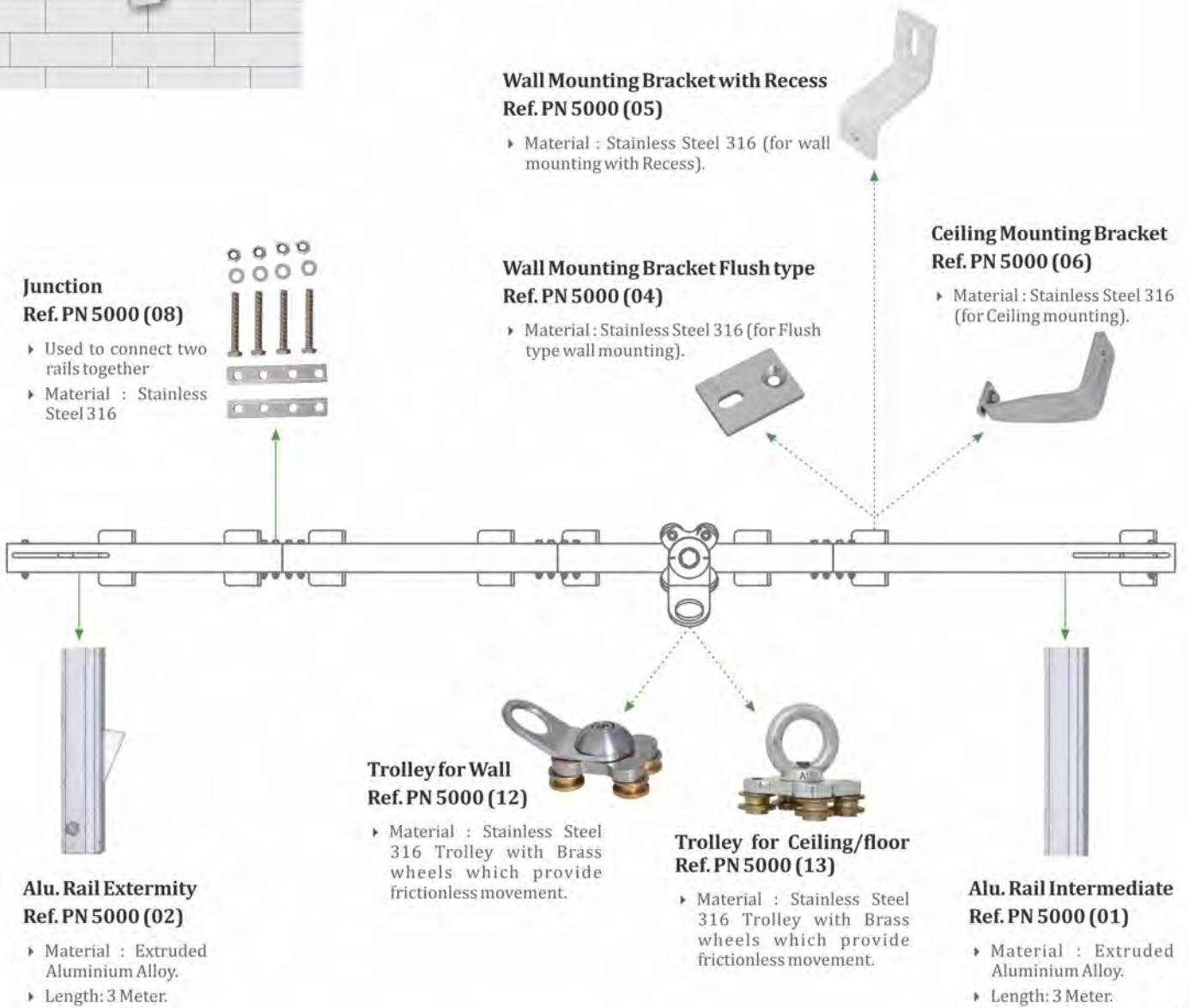

Mounting Nut Ref. PN 5000 (03)

- Material : Stainless Steel 316 to connect the rail to the mounting Bracket.



Curved Alu. Rail (outer wall mounted) Ref. PN 5000 (09A)

- Material : Extruded Aluminium Alloy.



Curved Alu. Rail (inner wall mounted) Ref. PN 5000 (09B)

- Material : Extruded Aluminium Alloy.



Curved Alu. Rail (Ceiling/Floor) Ref. PN 5000 (10)

- Material : Extruded Aluminium Alloy.





One of the biggest challenges in fall protection is when the anchorage is too high to access and the clearance distance is too small.

KARAM Retractable Fall Arrester Blocks provide an ideal solution for such a problem.



Retractable Fall Arrester Blocks

Challenges faced during work at Height

- ▶ While Working on towering heights.
- ▶ Work in areas having less clearance distance.
- ▶ Repeated work on a defined site, at a height.
- ▶ Lack of enough suitable Anchorage points.
- ▶ Confined Spaces.

KARAM Retractable Fall Arrester Blocks... the perfect solution for such tricky situations

FEATURES OF KARAM RETRACTABLE BLOCKS

- ▶ Can be anchored to a single point and allows the user to move uninhibited at different levels.
- ▶ The connecting lanyard is such that is retracts or extends to different lengths as required, is always taut with no slack.
- ▶ In the event of a fall, the block locks immediately with minimum fall distance & lowers the impact of force to less than 6 kN.

Casing	: Available in both robust & polymer casing and in Aluminium Casing
Lock Mechanism	: Unique centrifugal Braking Mechanism
Applications	: Ideal for Vertical use in various hazardous conditions for personnel weighing upto 136 Kgs.
Retractable Life Line	: Available in both Webbing & GI wire rope.
Harness End Connector	: Swivel Snap Hook with Load Indicator PN 162 which indicates a warning line when a Fall has occurred.
Conformity	: Tested and Certified. Conforms to EN 360:2002

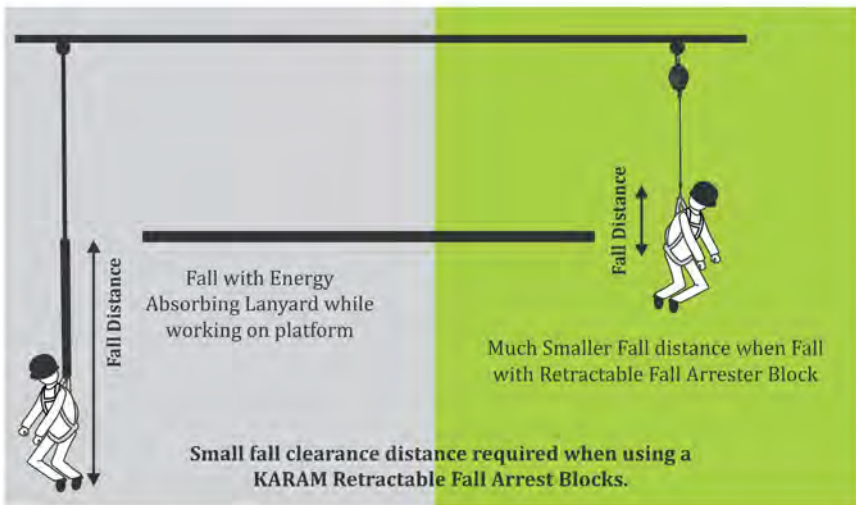

High Impact Resistant Polymer Casing of KARAM Retractable Fall Arrester Blocks



KARAM introduces a built in Side Handle with Special grip for perfect comfort during carrying of heavier blocks. This special handle comes incorporated in all Polymer casing, GI and Webbing lanyard Blocks of 10m size to 30m size.

KARAM ADVANTAGE

KARAM handle is placed on the side of the block. This enables easy carry of the block and also prevents the Retractable line to hit against the ground while walking (which may be a case if the handle were placed at the top)



HORIZONTAL USE OF KARAM WIRE ROPE BLOCKS

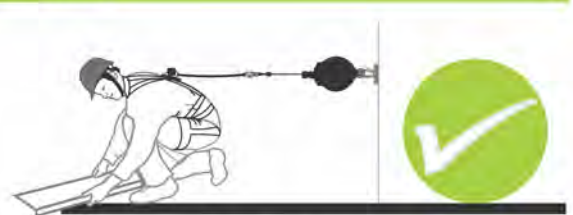
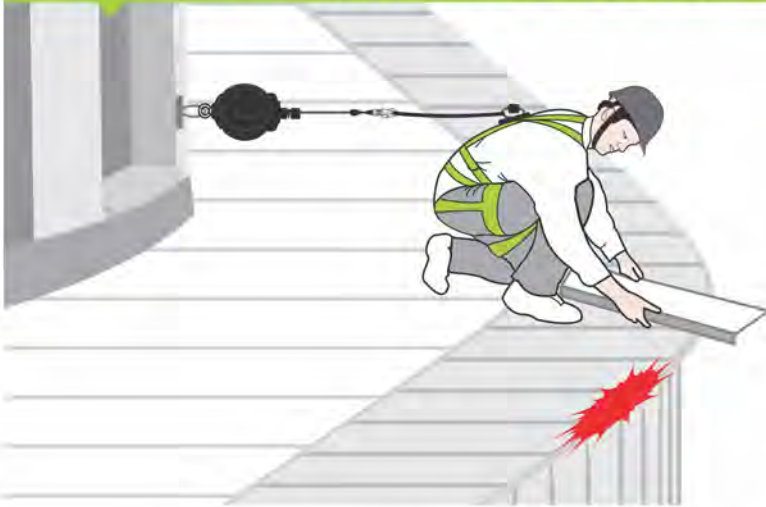

Can be used horizontally

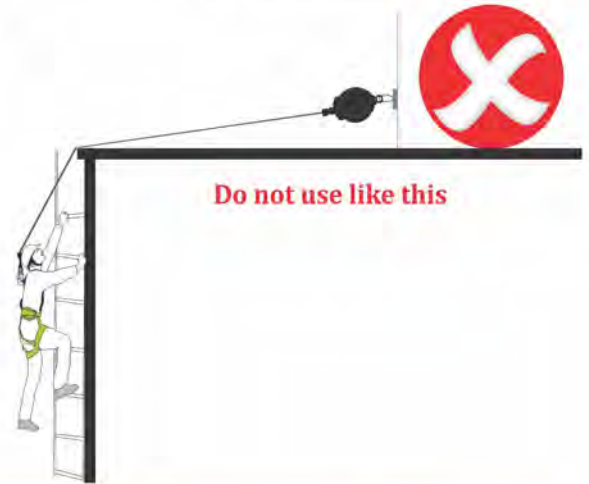

Do not use like this

Ref. PN 222 (TB)



KARAM Retractable Wire Rope Blocks can also be used horizontally. For such a use, it is recommended to attach additional Webbing Lanyard.

Ref. PN 222 (TB) of 1.5m.

KARAM RETRACTABLE WIRE ROPE BLOCKS ARE PROVIDED WITH A 'HOLDING SNOOT' MADE UP OF SOFT THERMOPLASTIC ELASTOMER.



The Snout minimizes the accidental locking of the Block when the wire rope is released suddenly.

The Holding snout provides dampening of the impact experienced on to the Block casing when the wire rope is released suddenly. This prevents the Block to 'lock' accidentally in such cases, and hence allows better usage.



It allows a safer and more comfortable grip on the wire rope when the Block is inspected for retraction and locking prior to use.

It is mandatory as for all other PPE to inspect the Block for its working (which includes retraction and locking of the wire rope) prior to each use. In the absence of the Holding Snout you may feel discomfort while retracting the wire rope to inspect the Block. The Holding Snout allows you to grip the wire rope safely as you retract it to test the Block for locking & retraction without any discomfort.

Click on <http://karam.in/videos/> to know more, or scan the QR code alongside



PULL DOWN THE LANYARD OF BLOCK USING THE TAG LINE

A TAG LINE IS ALWAYS PROVIDED ALONG WITH KARAM RETRACTABLE BLOCKS

Always allow the Retractable lanyard to recoil into the Block casing under control using the same Tag - line. The Retractable Block may lock if the Rope is suddenly released. Always use the Tag - Line.



Important :

The Damper Spring at the base of the block can be pushed up to release the block in the event the Block Wire gets blocked.

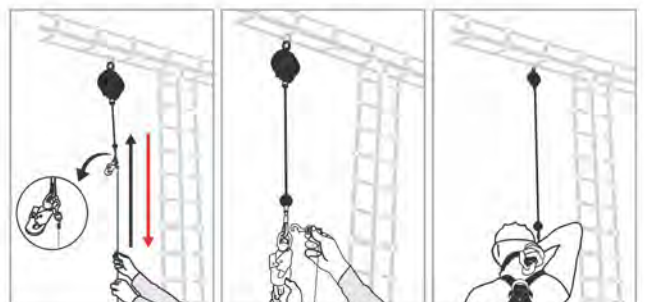

Click on <http://karam.in/videos/> to know more, or scan the QR code alongside





KARAM

Introduces

MICRON BLOCK

the lightest Retractable Fall Arrest Block in its range

Incorporated with robust & durable casing, this Micron Block is extremely light in weight & easy to carry. It is made up of finest material for longevity and extended use.

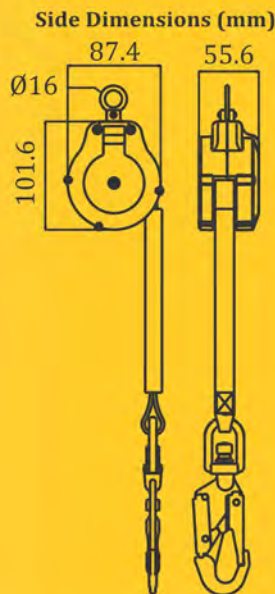

Micron Block Ref. MIC02

- ▶ Extremely light in weight, weighing less than 600 gms. Has inbuilt textile energy absorber.
- ▶ Material : Robust and durable polymer casing
- ▶ Maximum length of Retractable Webbing - 02 mtrs.
- ▶ Attachment End : Comes with Steel swivel hook PN 162 having impact indicator
- ▶ Minimum Breaking Strength : 15 kN
- ▶ Conforms to : EN 360:2002

Unique Features:

- ▶ Fall distance is minimal as compared to EA Lanyards hence Retrieval of fall victim is easier
- ▶ Pocket sized
- ▶ Can be easily carried, user friendly



Call **KARAM** Safety Expert
for further advise
Toll Free No.: 1800 103 7085

KARAM
Introduces
TWIN RETRACTABLE
Fall Arrester Block

To be used wherever the user needs a greater freedom of movement and needs to pass obstacles while remaining anchored at all times.



Twin Retractable Fall Arrester Block
Ref. ALWB 2X2

- ▶ Material : Casing made up of high strength and sturdy Aluminium Alloy
- ▶ Length of Retractable Webbing -
- ▶ Attachment End : Includes two Scaffold Hooks PN 131 at anchorage end
- ▶ Anchorage End : Anchorage Eye with swivel action. Prevents undue twist of webbing while working or in the event of a Fall
- ▶ Minimum Breaking Strength : 15 kN
- ▶ Conforms to : EN 360:2002

Ideal for use in scaffolding in Construction Industry

Side Dimensions (mm)

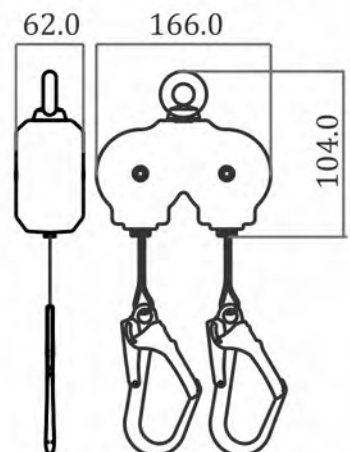

Call **KARAM** Safety Expert
for further advise
Toll Free No.: 1800 103 7085

KARAM

Introduces for the First Time

RETRIEVAL FALL ARRESTER BLOCK

in polymer Casing



To enable easy retrieval of a victim of fall. The block allows the fall to arrest and also allows easy hoist of the victim with the help of its Hoist handle.

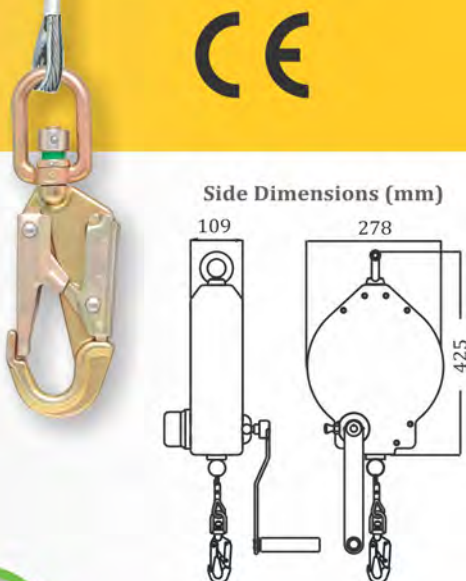

Retractable Block with Retrieval System

Ref : PCGS30R

- ▶ The locking pin on the side of the casing at the base of the handle allows this dual system to work in independent Fall Arrest & Winch modes.
- ▶ Can be easily mounted on the leg of KARAM Tripod PN800 using specialized brackets Ref. PN 800(09)
- ▶ Minimum Breaking Strength > 12kN
- ▶ Conforms to EN 360:2002 & EN 1496:2006 Class A

Unique Features:

- ▶ **The Dual mode-** helps easily movement of user while working in confined spaces
- ▶ **Retractable mode-** enables easy mount of user in Confined Space. Also provides Fall Protection
- ▶ **Winch mode-** enables easy retrieval
- ▶ Length of Wire Rope upto 30m
- ▶ Comes with PN 162 Snap Hook with Impact Indicator



Call **KARAM** Safety Expert
for further advise
Toll Free No.: 1800 103 7085

(PCWB02; PCWB02 SW)

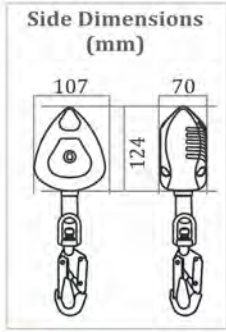

Retractable Block Polymer Casing with Webbing

Ref. PCWB02; PCWB02 (SW)

Material	Casing made up of high impact strength Polymer, to prevent breakage and is nearly indestructible.
Width of Webbing	25 mm
Attachment End	PN 162 Hook with load indicator
Minimum Breaking Strength	15 kN
Conforms to	EN 360:2002

Model	Length of Webbing	Weight (Kg)
PCWB02	2 mtr	1.22



*Also available with Swivel Eye at the Anchorage end. Ref: PCWB02 (SW)

(PCWB3.5; PCWB3.5 SW)

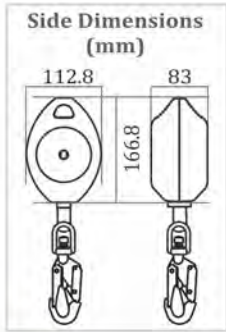

Retractable Block Polymer Casing with Webbing

Ref. PCWB3.5; PCWB3.5 (SW)

Material	Casing made up of high impact strength Polymer, to prevent breakage and is nearly indestructible.
Width of Webbing	25 mm
Attachment End	PN 162 Hook with load indicator
Minimum Breaking Strength	15 kN
Conforms to	EN 360:2002

Model	Length of Webbing	Weight (Kg)
PCWB3.5	3.5 mtr	1.65



*Also available with Swivel Eye at the Anchorage end. Ref: PCWB3.5 (SW)

(PCGS3.5; PCGS3.5 SW)

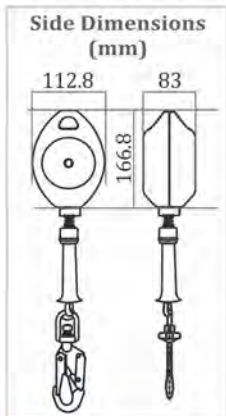

Retractable Block Polymer Casing with G.I. Wire Rope

Ref. PCGS3.5; PCGS3.5 (SW)

Material	Casing made up of high impact strength Polymer, to prevent breakage and is nearly indestructible.
Dia of Rope	Galvanized Steel Wire Rope of dia 4.5 mm
Attachment End	PN 162 Hook with load indicator
Minimum Breaking Strength	12 kN
Conforms to	EN 360:2002

Model	Length of Wire Rope	Weight (Kg)
PCGS3.5	3.5 mtr	2.23



*Also available with Swivel Eye at the Anchorage end. Ref: PCGS3.5 (SW)

* Also available with SS Wire Rope instead of G.I Respective references with SS Wire Rope shall be PCGS 3.5(SS)

* Atex Certified for use in potentially explosive atmosphere Directive 94/9/EC

(PCWB05; PCWB06)

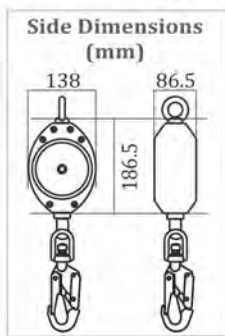

New

Retractable Block Polymer Casing with Webbing

Ref. PCWB05; PCWB06

Material	Casing made up of high impact strength Polymer, to prevent breakage and is nearly indestructible.
Width of Webbing	25 mm
Attachment End	PN 162 Hook with load indicator
Anchorage End	Anchorage Eye with swivel action. Prevents undue twist of rope while working or in the event of a Fall.
Minimum Breaking Strength	15 kN
Conforms to	EN 360:2002

Model	Length of Webbing	Weight (Kg)
PCWB05	5 mtr	2.36
PCWB06	6 mtr	2.40

(PCGS05 to PCWB07)

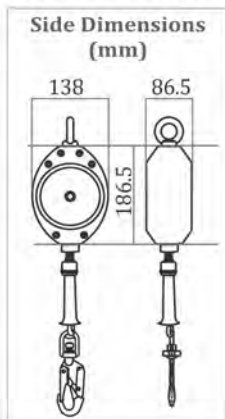

New

Retractable Block Polymer Casing with G.I. Wire Rope

Ref. PCGS05; PCGS06; PCGS07

Material	Casing made up of high impact strength Polymer, to prevent breakage and is nearly indestructible.
Dia of Rope	Galvanized Steel Wire Rope of dia 4.5 mm
Attachment End	PN 162 Hook with load indicator
Anchorage End	Anchorage Eye with swivel action. Prevents undue twist of rope while working or in the event of a Fall.
Minimum Breaking Strength	12 kN
Conforms to	EN 360:2002

Model	Length of Wire Rope	Weight (Kg)
PCGS05	5 mtr	2.97
PCGS06	6 mtr	3.06
PCGS07	7 mtr	3.16

* Also available with SS Wire Rope instead of GI. Respective references with SS Wire Rope shall be PCGS05(SS), PCGS06(SS) & PCGS07(SS)

* Atex Certified for use in potentially explosive atmosphere Directive 94/9/EC

(PCWB7.5)

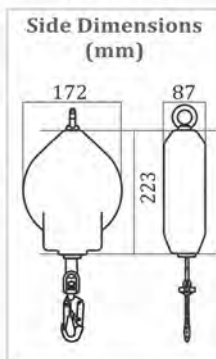

Retractable Block Polymer Casing with Webbing

Ref. PCWB7.5

Material	Casing made up of high impact strength Polymer, to prevent breakage and is nearly indestructible.
Width of Webbing	25 mm
Attachment End	PN 162 Hook with load indicator
Anchorage End	Anchorage Eye with swivel action. Prevents undue twist of rope while working or in the event of a Fall.
Minimum Breaking Strength	15 kN
Conforms to	EN 360:2002

Model	Length of Webbing	Weight (Kg)
PCWB7.5	7.5 mtr	3.36



(PCGS7.5 to PCGS10)

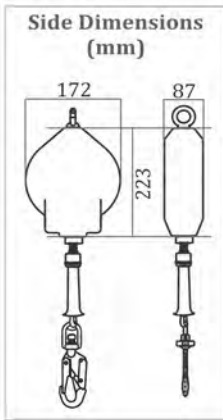

Retractable Block Polymer Casing with G.I. Wire Rope
Ref. PCGS7.5; PCGS08; PCGS09; PCGS10

Material	Casing made up of high impact strength Polymer, to prevent breakage and is nearly indestructible.
Dia of Rope	Galvanized Steel Wire Rope of dia 4.5 mm
Attachment End	PN 162 Hooks with load indicator
Anchorage End	Anchorage Eye with swivel action. Prevents undue twist of rope while working or in the event of a Fall.
Minimum Breaking Strength	12 kN
Conforms to	EN 360:2002

Model	Length of Wire Rope	Weight (Kg)
PCGS7.5	7.5 mtr	3.79
New PCGS08	8 mtr	3.84
New PCGS09	9 mtr	3.94
PCGS10	10 mtr	4.03

* Also available with SS Wire Rope instead of GI. Respective references with SS Wire Rope shall be PCGS7.5(SS), PCGS08(SS), PCGS09(SS) & PCGS10(SS)

* Atex Certified for use in potentially explosive atmosphere Directive 94/9/EC

(PCWB10; PCWB12)

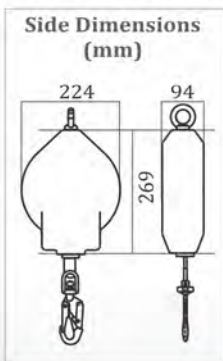

Retractable Block Polymer Casing with Webbing
Ref. PCWB10; PCWB12

Material	Casing made up of high impact strength Polymer, to prevent breakage and is nearly indestructible.
Width of Webbing	25 mm
Attachment End	PN 162 Hook with load indicator
Anchorage End	Anchorage Eye with swivel action. Prevents undue twist of rope while working or in the event of a Fall.
Minimum Breaking Strength	15 kN
Conforms to	EN 360:2002

Model	Length of Webbing	Weight (Kg)
PCWB10	10 mtr	5.65
PCWB12	12 mtr	5.73

(PCGS12 to PCWB20)

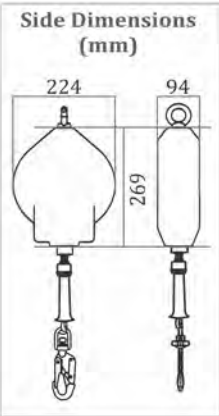

Retractable Block Polymer Casing with G.I. Wire Rope Ref. PCGS12; PCGS15; PCGS18; PCGS20

Material	Casing made up of high impact strength Polymer, to prevent breakage and is nearly indestructible.
Dia of Rope	Galvanized Steel Wire Rope of dia 4.5 mm
Attachment End	PN 162 Hook with load indicator
Anchorage End	Anchorage Eye with swivel action. Prevents undue twist of rope while working or in the event of a Fall.
Minimum Breaking Strength	12 kN
Conforms to	EN 360:2002

Model	Length of Wire Rope	Weight (Kg)
PCGS12	12mtr	6.10
PCGS15	15 mtr	6.39
PCGS18	18 mtr	6.67
PCGS20	20 mtr	6.86

* Also available with the SS Wire Rope instead of GI. Respective references with SS Wire Rope shall be PCGS12(SS), PCGS15(SS), PCGS18(SS) & PCGS20(SS)

* Atex Certified for use in potentially explosive atmosphere Directive 94/9/EC

(PCGS25 to PCWB30)

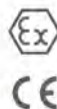
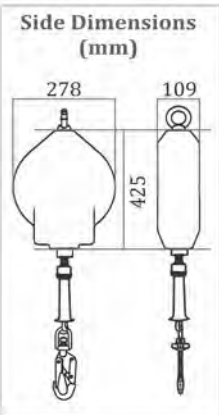

Retractable Block Polymer Casing with G.I. Wire Rope Ref. PCGS25; PCGS30

Material	Casing made up of high impact strength Polymer, to prevent breakage and is nearly indestructible.
Dia of Rope	Galvanized Steel Wire Rope of dia 4.5 mm
Attachment End	PN 162 Hook with load indicator
Anchorage End	Anchorage Eye with swivel action. Prevents undue twist of rope while working or in the event of a Fall.
Minimum Breaking Strength	12 kN
Conforms to	EN 360:2002

Model	Length of Wire Rope	Weight (Kg)
PCGS25	25 mtr	12.39
PCGS30	30 mtr	12.87

* Also available with the SS Wire Rope instead of GI. Respective references with SS Wire Rope shall be PCGS 20(SS), PCGS 25(SS) & PCGS 30(SS)

* Atex Certified for use in potentially explosive atmosphere Directive 94/9/EC



Call **KARAM** Safety Expert
for further advise
Toll Free No.: 1800 103 7085

**Also available in
Aluminium Casing**

LENGTHS

ALWB 04 to ALWB 7.5; ALGS 05 to ALGS 10;
ALWB 10 - ALWB 12; ALGS 12 to ALGS 20





Confined Space Entry



A particularly challenging area of activity is when the worker is required to move into confined spaces. KARAM provides equipment that allows easy overhead access into and retrieval of personnel and material from such confined space areas.



Call **KARAM** Safety Expert
for further advise
Toll Free No.: 1800 103 7085

Tripod Ref. PN 800

KARAM Tripod is one such product that can be used for easy access by a worker into confined spaces such as Man-holes, Tanks, etc. It provides a means of controlled ascent and descent, as well as protection from falls, should the depth of the space require it.

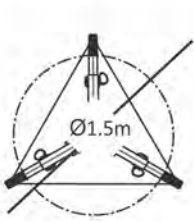

Tripod Head : Robust Aluminium Alloy cast head with two integral pulleys for smooth operation of the Winch.



Aluminium Eye Bolts : Tested to sustain a force of more than 10 kN static force as per EN 795 CLASS B.

Telescopic Legs : Fully Adjustable Aluminium Telescopic Legs for use on level or uneven surfaces.

Sturdy Rubber Shoes : Sturdy Rubber Shoes provided with High Abrasion Resistant Sole to increase friction and impart more stability to the Tripod.



CE

PN 800 (7ft.)



CE

PN 800 (10ft.)

Tripod Ref. PN 800

- ▶ For access in confined spaces
- ▶ With two mounted pulleys at the head of the Tripod in the prolongation of the main leg for passing a cable
- ▶ It allows making configuration with one winch and one Self Retractable block with hoisting Facility with PCGS 30R
- ▶ Having two auxiliary eye bolts as attachment points.
- ▶ Aluminum alloy cast head, legs in aluminium.
- ▶ Steel support-shoes provided with rubber sole to increase friction and impart more stability.
- ▶ Strength of anchorage point greater than 12 kN
- ▶ Every Tripod is provided with inbuilt fixture for attaching our winch PN 801 (can be supplied without this fixture on special request).
- ▶ Every Tripod is provided with Tripod Bag Ref. PN 904

Length	Specification	Compliance
7 ft.	<ul style="list-style-type: none"> ▶ Fully adjustable telescopic legs, adjustable height from 1.15m to 2.15m ▶ Wheelbase (Footprint) : 1.5m Diameter ▶ Weight : 13 kg ▶ Maximum load capacity : 500 kg 	EN 795:2012 TYPE B
10 ft.	<ul style="list-style-type: none"> ▶ Fully adjustable telescopic legs, adjustable height from 1.9m to 2.9m ▶ Wheelbase (Footprint) : 1.8m Diameter ▶ Weight : 15 kg ▶ Maximum load capacity : 500kg 	

Winch Ref. PN 801

- ▶ To be used for raising or lowering of personnel or material into confined spaces
- ▶ Equipped with Advanced Dual Load Advantage (DLA) Gear System within to give and effortless use of the Winch.
- ▶ Equipped with bolting fixture for robust fitting on to the tripod PN 800
- ▶ Lifting Load capacity : 135 Kgs.
- ▶ Length: 20.m & 25.m
- ▶ Conforms to EN 1496:2006 (Class A)
- ▶ To be used with a Retractable Fall Arrester when deployed for raising or lowering a person
- ▶ Can also be fitted to KARAM K-Pod PN 900
- ▶ Also available with the SS Wire Rope instead of GI. Respective references with SS Wire Rope shall be PN 801(20)SS & PN 801 (25)SS.



CE

Ref. No	Length
PN 801 (20)	20m
PN 801 (25)	25m

Tripod Bag Ref. PN 904



KARAM Cantilever K-Pod Ref. PN 900

Features :

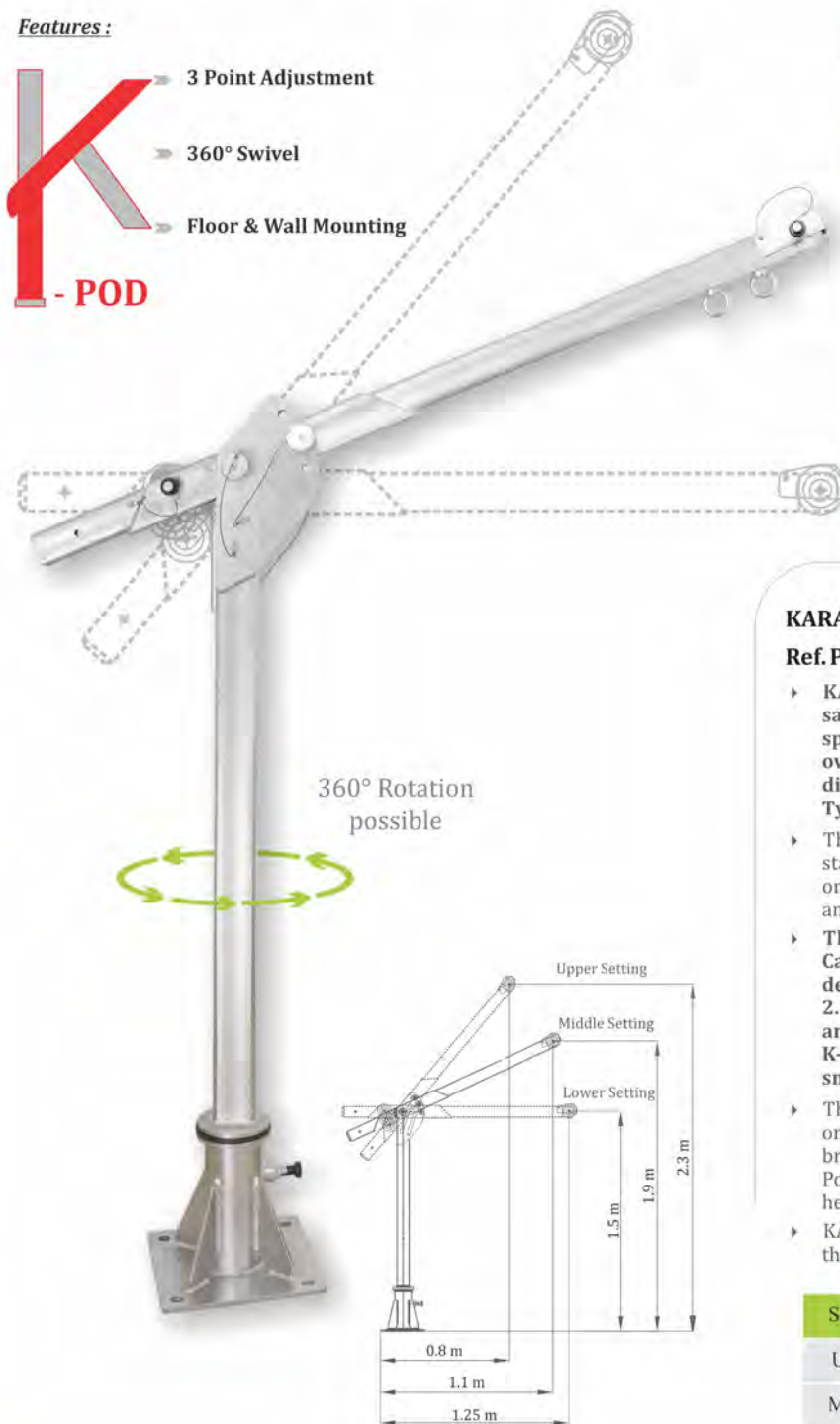

KARAM Cantilever K-Pod Ref. PN 900

- ▶ KARAM introduces the new K-Pod which provides a safe and sure system for easy access to confined spaces. The K-Pod is an ideal choice to provide overhead anchorage which can be mounted on different bases and it conforms to EN 795 : 2012 Type B
- ▶ The K-Pod is made of highly corrosion resistant stainless steel, and can swivel a complete 360 degrees on its mounted base, hence providing a versatile reach and access.
- ▶ The unique feature is that the height of the Cantilever arm of the K-Pod is adjustable at 3 defined points, with upper height adjustment of 2.3m, middle arm adjustment of 1.9m, and lowered arm adjustment at 1.5m. This enables the use of the K-Pod even in those areas where the roof height is small.
- ▶ The K-Pod can be easily mounted on the floor as well as on the wall through special floor and wall mounting brackets which are made available as per need. The K-Pod can also be mounted on the floor of heavy vehicles, hence making it extremely versatile in use.
- ▶ KARAM Winch PN 801 can also be easily mounted on to the K-Pod with the help of stainless steel fasteners.

Setting	Distance from Bar	Height of Arm
Upper	0.8m	2.3m
Middle	1.1m	1.9m
Lower	1.25m	1.5m

Accessories of KARAM K-Pod



Floor Mounting Bracket
Ref. PN 900(01)



Wall Mounting Bracket
Ref. PN 900(02)



Stainless Steel Fasteners for Winch Mounting
Ref. PN 900(03)



Rope Access & Rescue

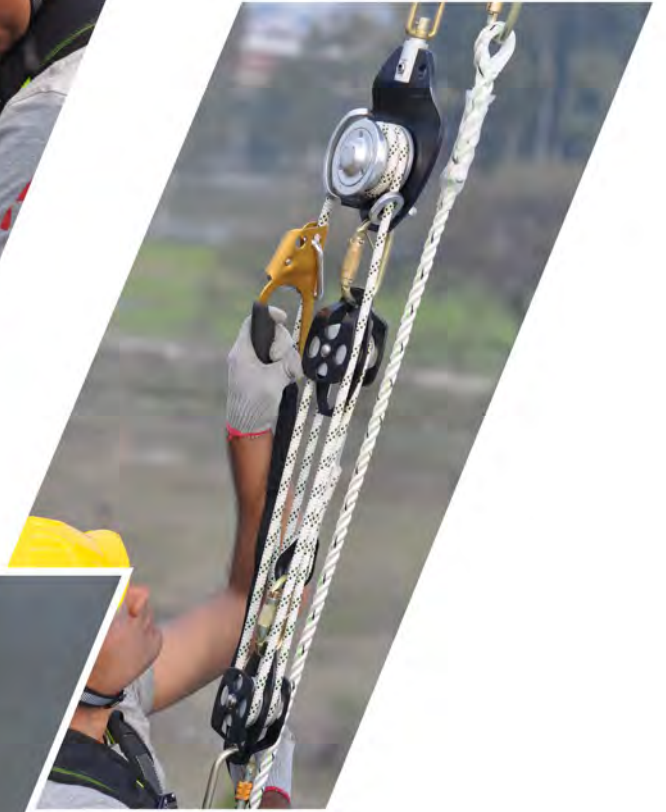

Rope Access technique of movement on a rope should only be used when traditional access systems cannot be installed. The basic rope access equipment should be used with a fall protection system. **Rescue** technique is used in an emergency hence it is naturally the most sensitive. This intervention can be performed by the user him/herself, if he/she is conscious and has the necessary equipment for self-extraction, or by a helper. In this situation it is necessary to be able to reach the victim, release him/her in complete safety and move the person upwards or downwards.

New

KOMFY KRUZE System

A Versatile Ascend-Descend
Rescue Roll System
by **KARAM**

A particularly challenging area of work is one, which requires rapid transition between raising and lowering of self, or during rescue of a fall victim at any given site.

A worker might feel the need to, at times, descend to a particular level to perform his job, and at times, raise himself to another working level along the same plane. Maneuvering becomes even more difficult where ladders and rungs are unavailable for use.

A similar challenge is also encountered while executing a rescue activity.

KARAM introduces a Komfy Kruze system Versatile Ascent/ Descent Rescue Roll System, which allows the user to raise and lower himself with ease while working at a height in suspended position. The device is also used to rescue an individual by either raising or lowering the victim to the ground or next level.

KARAM Advantage

- ▶ Unidirectional movement of the rope roller provides sufficient friction to the rope for controlled descent in case of a fall.
- ▶ The material of construction of Aluminium Alloy ...
- ▶ The anti-reverting pulley counterbalances the body weight of the user, thus requiring minimum effort to operate.

Unique Features-

1. A single person can easily operate the device to raise or lower himself with considerable ease.
2. Unidirectional movement of the rope-roller allows the rope to hold itself in place, hence prevents any reel-back.
3. While use in suspended work positioning, the entire control of the device is in the hands of the user, hence ensures his complete safety.
4. It is a versatile system made up of Aluminium and steel components, which are *light in weight* and highly corrosion resistant.
5. The system is provided in a *fully assembled factory fitted 3:1 or 5:1 hauling ratio*.
6. It comes with an Ascending Handle along with a Safety sling. This arrangement *stops the descent in case it is accidentally released*.
7. The rope used is a KARAM Kernmantle rope of Diameter 10.5mm. This rope is *tested for strength, is abrasion resistant*, and comes fitted in the system in lengths as per requirement.
8. *Suitable for use for maximum personal load of 150 kgs.*
9. *Conforms to EN 341 Class A and EN 1496:2006 Class A.*





Features of **KOMFY** **KRUZE System**

Ref. PN 404

The device has a swivel-enabled ring at its anchorage termination. This unique feature allows it to easily rotate about its axis, in case the rope twists, hence prevents unwanted spinning of the user.

Its special design also prevents the rope from slipping off the sides.



It operates in accordance with the principle of **winding-contact friction**, which results from the rope being wound around it. It can be turned freely in the anti-clockwise direction, while it locks in the clock-wise direction. **This allows unidirectional movement of the rope, allowing effortless ascent and controlled descent.**

It is made up of aluminium alloy and stainless steel, and is highly corrosion resistant. The smooth finish ensures minimum abrasion of the rope that runs over it.

The rope retention guide prevents the rope from twisting or overlapping, and also ensures that the rope is in constant contact with the rope roller, that controls the friction over the rope.

The **anti reversing pulley** counter-balances the body weight of the user, thus requiring **minimum effort** to operate.



Knotless design The Rope is terminated by stitching & not by a knot, hence ensuring that the system is always intact, and no part gets disengaged.



The sling provided with the ascent handle- The ascent handle is provided with a Holding Sling. The Karabiner is connected to the sternal D-Ring of the user. In the event of accidental release of the handle, is still made accessible to the user..



Call **KARAM** Safety Expert
for further advise
Toll Free No.: 1800 103 7085

Click on <http://karam.in/videos/> to know more,
or scan the QR code alongside



The **Komfy Kruze System** is provided in configurations of two different hauling ratios **3:1** and **5:1**. They come pre-installed from the factory in a tangle-free packaging, enabling **immediate and easy use** when needed.



Call **KARAM Safety Expert** for further advise
Toll Free No.: 1800 103 7085

Ref. PN 660(3:1)

Mechanical Advantage : 1/3

Ref. PN 660(5:1)

Mechanical Advantage : 1/5

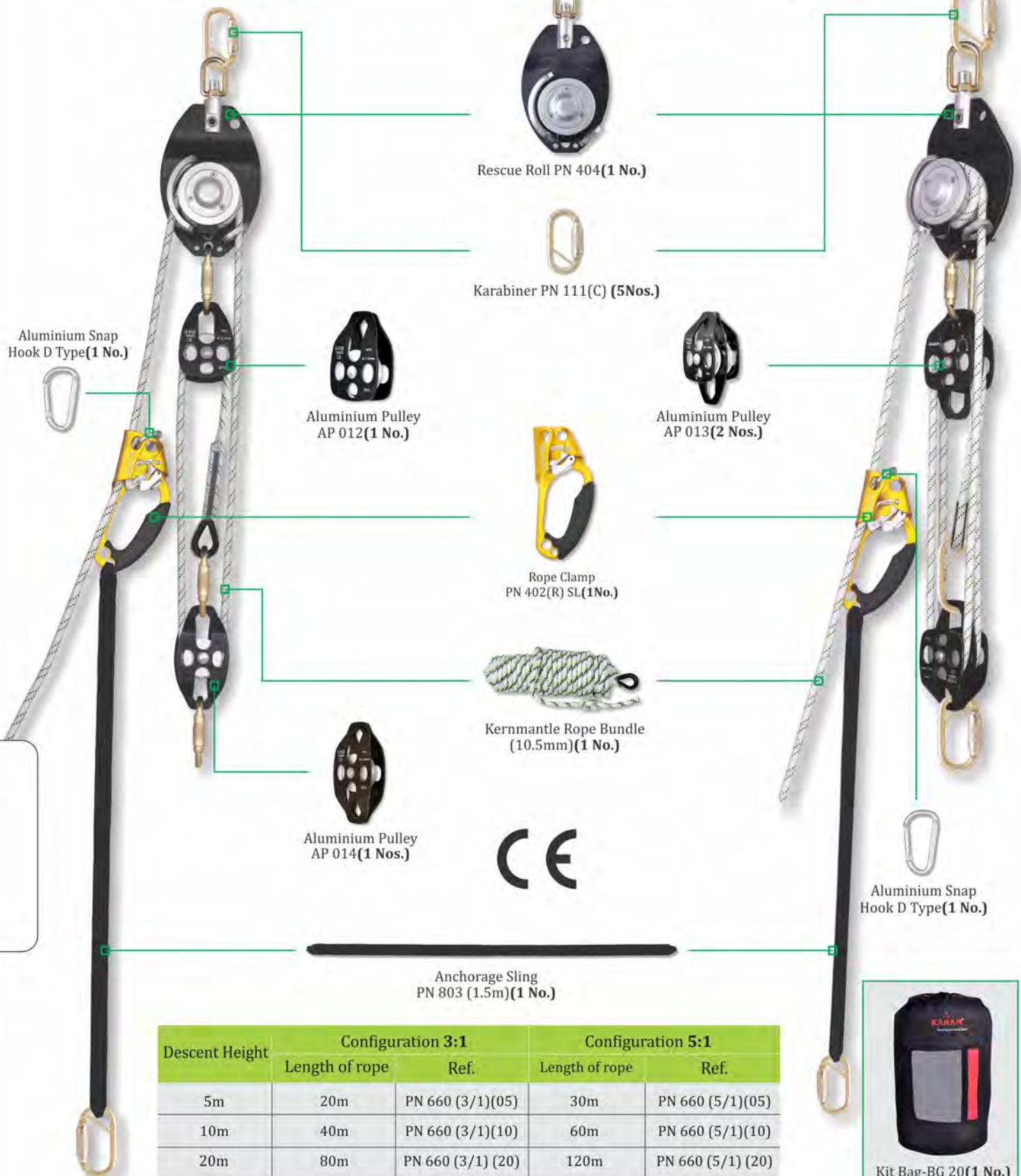

Descent Height	Configuration 3:1		Configuration 5:1	
	Length of rope	Ref.	Length of rope	Ref.
5m	20m	PN 660 (3/1)(05)	30m	PN 660 (5/1)(05)
10m	40m	PN 660 (3/1)(10)	60m	PN 660 (5/1)(10)
20m	80m	PN 660 (3/1) (20)	120m	PN 660 (5/1) (20)







EVAC™

KARAM Introduces **EVAC** a multi-functional device that allows various applications like Rescue, Self evacuation, Automatic controlled descent etc.

The Evac has an automatic speed regulation, controlled by highly mechanical four point centrifugal force mechanism.

Highly corrosion resistant body and extremely light in weight.

New

Ref. PN 406



- Swivel Anchorage Eye
- Horn for manual maneuvering during descent
- Knob to set the mode for clock wise/ anticlock wise movement of rope
- Robust, Light Weight, Corrosion Resistant Aluminium Alloy body
- 10.5mm dia Kernmantle Rope
- Stitched end of the rope
- Thimble to allow abrasion-free connection of rope with connector



Evac can be used for a maximum descent height of upto 150m

New

Aluminium Rebar Hook

Swivel Base

Ref. PN 407



Features :

- ▶ Ideal for multiple Evacuation. Enables rapid escape & rescue and descent.
- ▶ Made of highly corrosion resistant Aluminum Alloy.
- ▶ High functional Safety.
- ▶ Extremely light in weight.
- ▶ Compact & stable size.
- ▶ Has an automatic speed regulation.
- ▶ Resistant to damp, heat & cold.
- ▶ Descent speed controlled at 0.9m/sec to 1.2m/sec.
- ▶ Comes with KARAM Kernmantle Rope of dia 10.5mm permanently assembled to the system.
- ▶ Sufficient length of rope is provided assemble with the product, to allow descent as per requirement.
- ▶ Both termination ends of the rope is equipped with special polymer eyes to allow abrasion free connection with Hooks.
- ▶ Evac can be used for a maximum descent height of upto 150m.
- ▶ The Anchorage end of EVAC is provided with unique swivel functioning. This prevents undue twisting of rope during usage.
- ▶ Equipped with special horn for additional manual control of speed during descent and positioning.
- ▶ Conforms to EN 341.

Ref. No.	Anchorage end	Weight
PN 406	Anchorage eye	1.385 kg
PN 407	A1u. Rebar Hook PN 136	1.830 kg



The Evac PN 406 has three-mode working

- ▶ **Mode 1** - Allows only clockwise descent of rope restricting movement on opposite side.
- ▶ **Mode 2** - Allows descent of the rope in both clockwise and anti clockwise directions.
- ▶ **Mode 3** - Allows only anti-clockwise descent of the rope, restricting descent on opposite side.

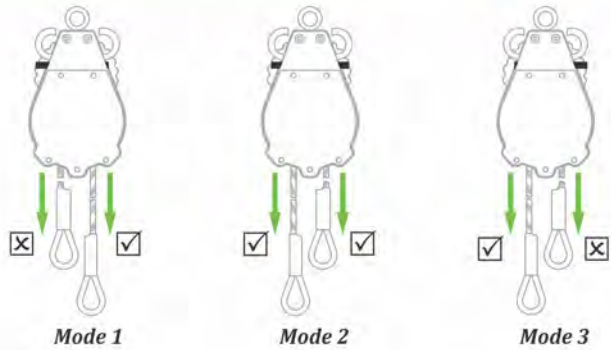

Use of EVAC in Emergency Evacuation

KARAM EVAC is an ideal choice of equipment for use in situation of emergency evacuation from high rise structures like tall buildings of hotels and offices, such a situation is encountered in cases of fire, or similar disaster situations in these areas. The biggest challenge faced by victims or rescuers alike is the need to escape to the ground level safely and at the earliest.

The EVAC can be anchored to anchor points, present on the outer fascades near a suitable evacuation window.

A person can attach one end of the Kernmantel rope to his harness or the Evacuation triangle D-Ring and immediately jump out of the window, the other end of the Kernmantle Rope moves up while the first person is evacuating. This other end is then used by the next person who is similarly attached with his harness and evacuate.

Click on <http://karam.in/videos/> to know more, or scan the QR code alongside



Recommended Accessories for use with EVAC:

1. For Anchorage – Anchorage Slings or Point Anchorages like SA 09.
2. For Multiple evacuation – Evacuation Triangle PN 852.
3. Body Support or Harness For Descent – Magna or Full body harness PN 56.
4. Quarter Turn Locking Connectors – PN 111.

Use of EVAC for controlled manual Descent and Positioning:

KARAM Evac PN 406 can be attached directly to the Ventral D-Ring a Suspension Harness (PN 56 or Magna 3). Using the tension in the rope while pulling it outward on one horn the device can be used for controlled descent. For positioning at the certain height this end of the rope is wound around both the EVAC horns so that the worker can be locked in the required suspended position.

The user can manually control the speed of the descent.



EVAC-RTM

This Unique device comes with the feature of controlled descent along with an integral rescue winch function. Hence Evac-R is an ideal equipment for use in rescue and retrieval.

The additional handle mechanism provided in the EVAC R allows the victim of fall to be raised enough so as to release him from his fall arrest device.



Features:

- ▶ Ideal equipment for use in rescue and evacuation
- ▶ Comes with the feature of controlled descent along with an integral rescue winch function
- ▶ Made of highly corrosion resistant Aluminum Alloy
- ▶ High functional Safety
- ▶ Resistant to damp, heat & cold
- ▶ Descent speed controlled at average 1.1m/sec
- ▶ Comes with KARAM Kernmantle Rope of dia 10.5mm permanently assembled to the system
- ▶ Sufficient length of rope is provided assembled with the product to allow descent of upto 150m
- ▶ Both termination ends of the rope is provided with textile loops for connection with Hooks.
- ▶ The Anchorage end of EVAC-R is provided with unique swivel functioning. This prevents undeude twisting of rope during usage
- ▶ Conforms to EN 341 & EN 1496:2006

Ref. No.	Anchorage end	Weight	Hoisting Capacity
PN 408	Anchorage eye	2.135 kg	100 kg
PN 409	Alu. Rebar Hook PN 136	2.580 kg	100 kg



The Evac-R PN 408 has three-mode working

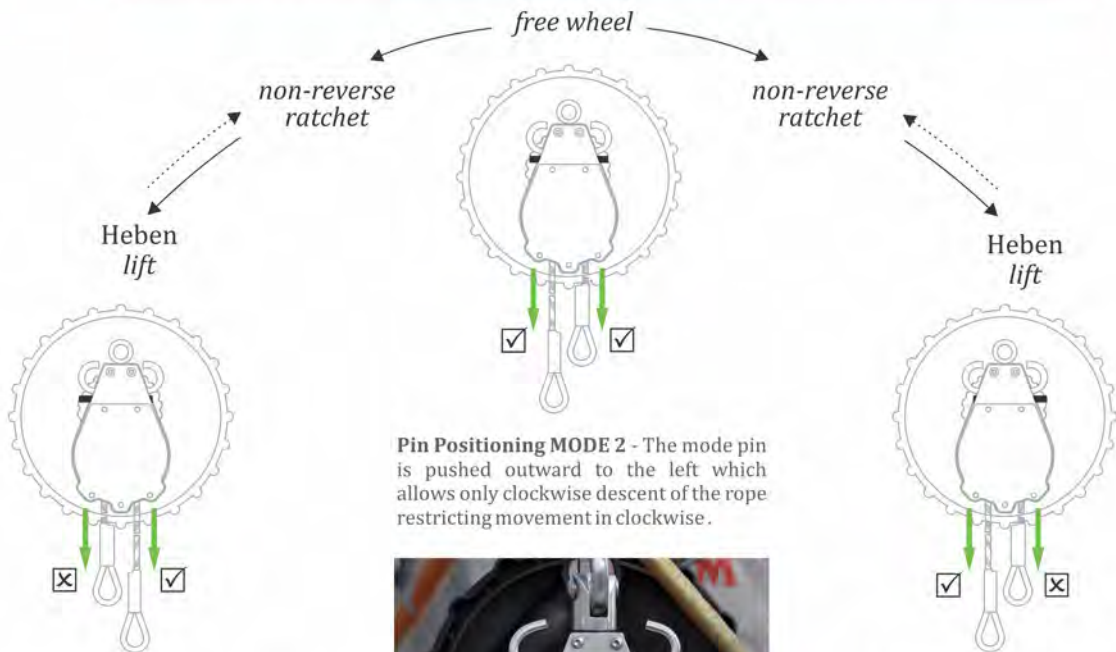

Pin Positioning MODE 1 - Position the mode pin in the middle for ideal working of the EVAC. This mode allows movement of the rope for descent in both clockwise and anti-clockwise direction.

Pin Positioning MODE 2 - The mode pin is pushed outward to the left which allows only clockwise descent of the rope restricting movement in clockwise.



Pin Positioning MODE 3 - The mode pin is pushed outward to the right which allows only clockwise descent of the rope restricting movement in anti-clockwise.

Click on <http://karam.in/videos/> to know more, or scan the QR code alongside



The Winch handle in EVAC-R is built of light sturdy polymer. It can be folded back into the wheel to allow unhindered descent.

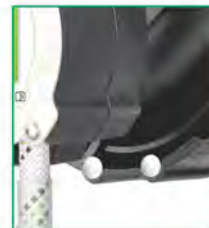

The wheel is provided with a counter weight to minimize any vibration at the time of descent.

Rescue Using Evac-R

A rescue operation can be carried out with the help of Evac R anchored overhead the fall victim. One end of the Kernmantle rope is attached to the Dorsal D-Ring of the victim, and using the winch. The EVAC-R allows the victim to descent at a controlled speed the victim is raised to release him from this fall arrest device.



Call **KARAM** Safety Expert for further advise
Toll Free No.: 1800 103 7085

Rope Access

Grip Descender
Ref. PN 401

Various work applications like window cleaning, exterior facade maintenance, crack filling, bridge expansion e.t.c require the worker to be suspended from height.

KARAM grip descender is a light weight easy to operate device that is used with a Suspension harness (PN 56, Magna3). For additional comfort an Easy Seat can be used with the Suspension harness.

It is a manually operated controlled descent device, ideal for descent on a single rope.

It is important to use appropriate fall arrest system along with the KARAM grip descender.

This is also an ideal device which can be used by trained personnel in an emergency situation for Rescue, to lower a casualty from an elevated work station.



Functioning Principles

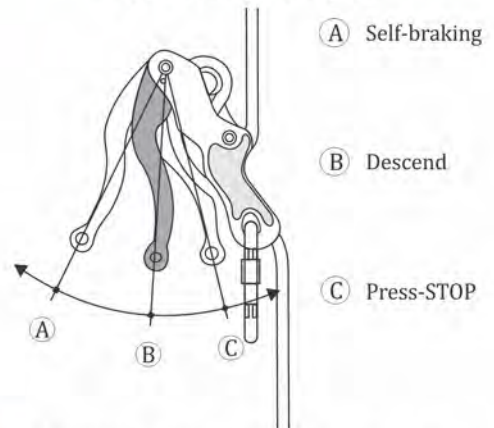

KARAM grip descender for positioning along with back up fall arrest system

Features:

- ▶ Works on a 10.5 mm Kernmantle Rope.
- ▶ Material of construction is Aluminium Alloy. It is extremely light in weight and highly corrosion resistant.
- ▶ Equipped with a unique dual self-braking system which initiates the brake as soon as the handle is released or clasped too tightly. (in panic situations)
- ▶ Conforms to EN 341-Class A.

KARAM GRIP DESCENDER IS IDEAL FOR RESCUE

Ideal For Rescue

(a) RESCUE EVACUATION - Descent Assisted by Rescuer

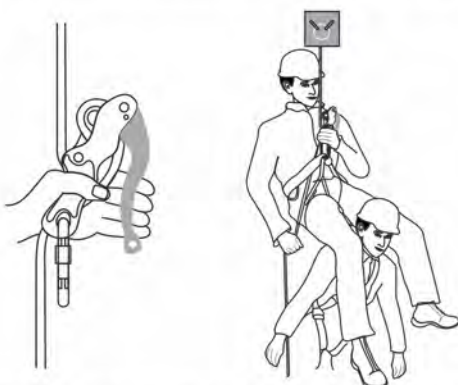

(b) RESCUE EVACUATION - From a Fixed Anchor-point

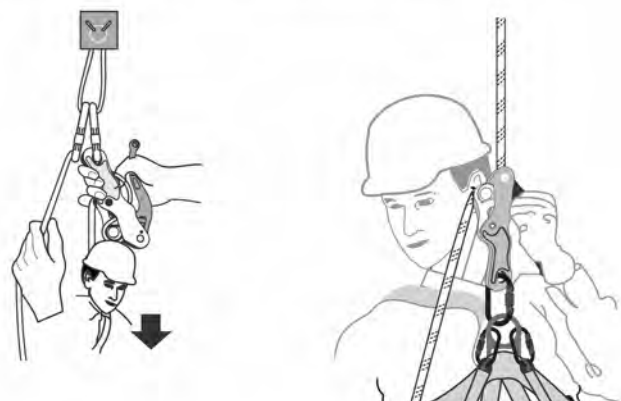

RESCUE : Push the handle into the middle position to descend



Figure of 8
Ref. PN 431

- ▶ Made up of Aluminium alloy.
- ▶ Inner dia Big-52mm, Small-26mm.
- ▶ Length - 145mm.
- ▶ Weight - 140gm.
- ▶ Minimum Breaking Load- 50kN.
- ▶ Finish - Natural Silver; Coloured, Anodized.



Rescue Sling
Ref. PN 401 (A)

It is used to anchor a victim of fall to the Rescuer during rescue. It is made of Polyamide Twisted rope of length 0.5m having loops for attachment.

KARAM Rope Clamp

KARAM Rope Clamps can be used for progression on ropes and also for creating Haul Systems.



Connecting hole for creating a pulley/rope clamp combination or for guiding the rope

Toothed Cam

Molded Grip

Connecting holes for foot loop and lanyards

Rope Clamp
Ref. PN 402 (R)
PN 402 (L)

- ▶ Net Weight: 196gm.
- ▶ For use on single rope 8 to 12mm Diameter Kernmantle Rope.
- ▶ Finish: Coloured, Anodized.
- ▶ Conforms to EN 567:2013.

Features :

- ▶ Made up of Aluminium Alloy which is highly corrosion resistant and extremely light in weight(less than 200 gms)
- ▶ Ideal for use on single Kernmantle rope of dia 8-12 mm
- ▶ The unique design of the Cam allows optimal grip on the rope without damaging it.
- ▶ The Moulded Grip on the handle is ergonomically designed to allow easy and effortless grip.
- ▶ It is available as both right and left hand models.
- ▶ Conforms to EN 567:2013

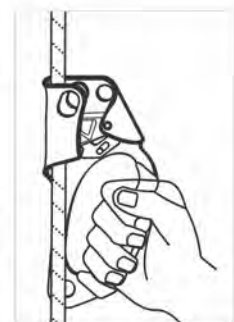

Call **KARAM** Safety Expert
for further advise
Toll Free No.: 1800 103 7085



Adjustable Webbing Foot Loop Ref. PN 402 (A)

- ▶ Material: 44mm Polyester Webbing.
- ▶ Attached to the Ascending rope clamp for rope ascents.
- ▶ Underfoot strap is abrasion-resistant and is slightly rigid to make it easier to step into.
- ▶ Length easily adjusted with the combination Buckles.

New



CE



Ventral Rope Clamp Ref. PN 405

- ▶ Material: Aluminium Alloy.
- ▶ Net Weight: 157gm.
- ▶ For use on single rope 8 to 12mm.
- ▶ Finish: Coloured, Anodized.
- ▶ Conforms to EN 567:2013.

Pulley



CE

Steel Single Pulley Single Side Attachment Ref. AP001

- ▶ Material: Alloy Steel.
- ▶ Minimum Breaking Strength: 30kN.
- ▶ Finish: Silver or Golden Yellow Galvanized.
- ▶ Net Weight: 412gm.
- ▶ Conforms to EN 12278:2007.



CE

Steel Single Pulley Double Side Attachment Ref. AP002

- ▶ Material: Alloy Steel.
- ▶ Minimum Breaking Strength: 30kN.
- ▶ Finish: Silver or Golden Yellow Galvanized.
- ▶ Net Weight: 500gm.
- ▶ Conforms to EN 12278:2007.

New



CE

Aluminium Single Pulley Single Side Attachment Ref. AP011

- ▶ Material: Aluminium Alloy.
- ▶ Minimum Breaking Strength: 30kN.
- ▶ Finish: Natural Silver / Coloured Anodized.
- ▶ Net Weight: 90gm.



CE

Aluminium Single Pulley Single Side Attachment Ref. AP012

- ▶ Material: Aluminium Alloy.
- ▶ Minimum Breaking Strength: 45kN.
- ▶ Finish: Natural Silver/Coloured Anodized.
- ▶ Net Weight: 234gm.
- ▶ Conforms to EN 12278:2007.



Call **KARAM** Safety Expert
for further advise
Toll Free No.: 1800 103 7085

New



**Aluminium Double Pulley Double Side Attachment
Ref. AP013**

- ▶ Material: Aluminium Alloy.
- ▶ Minimum Breaking Strength: 45kN.
- ▶ Finish: Natural Silver/Coloured Anodized.
- ▶ Net Weight: 90gm.
- ▶ Conforms to EN 12278:2007.

New



**Aluminium Single Pulley Double Side Attachment
Ref. AP014**

- ▶ Material: Aluminium Alloy.
- ▶ Minimum Breaking Strength: 45kN.
- ▶ Finish: Natural Silver/Coloured Anodized.
- ▶ Net Weight: 275gm.
- ▶ Conforms to EN 12278:2007.



Kernmantle Rope Semi Static

- ▶ Made up of Polyamide.
- ▶ Available in various length on request.
- ▶ Maximum Roll Size: 300 mts.
- ▶ Available in Dia of: 9mm, 10.5mm, 11mm.

Dia	Length (in meters)		
	10m	20m	30m
9mm	PN 910K(90)	PN 920K(90)	PN 930K(90)
10.5mm	PN 910K(105)	PN 920K(105)	PN 930K(105)
11mm	PN 910K(110)	PN 920K(110)	PN 930K(110)

(Ref: No. in similar pattern for larger lengths)

ROPE



Twisted Rope

- ▶ Made up of Polyamide.
- ▶ Available in various length on request.
- ▶ Maximum Roll Size: 200 mts.
- ▶ Available in Dia of: 12mm, 14mm, 16mm.

Dia	Length (in meters)		
	10m	20m	30m
12mm	PN 910(120)	PN 920(120)	PN 930(120)
14mm	PN 910(140)	PN 920(140)	PN 930(140)
16mm	PN 910(160)	PN 920(160)	PN 930(160)

(Ref: No. in similar pattern for larger lengths)



**Call KARAM Safety Expert
for further advise
Toll Free No.: 1800 103 7085**



Accessories

KARAM also provides equipment which when used, aide in easy rescue and rope access operations.



Edge Protector

Ref. ARC02

- ▶ KARAM Edge Protector made of Stainless Steel, protect the rope from abrasion against an edge.
- ▶ The edge Ring-Guides on the angle of the edge-protector keep different rope anchor lines from getting entangled over the edge.
- ▶ Design - Angle Shaped EDGE Protector.
- ▶ Material - Stainless Steel.
- ▶ Finish - Polished Stainless Steel
- ▶ Weight - 570.0 gm ± 20 gm

Evacuation Triangle

Ref. PN852

- ▶ To be used for rescue of injured personnel.
- ▶ Contains 3 metallic D-Rings at attachment elements.



Spreader Bar

Ref. IMP005 (01)

- ▶ Is available as an optional Accessory to the Pilot Chair, provided on request.



Pilot Chair

Ref. IMP005

- ▶ Ergonomic and comfortable working chair.
- ▶ For vertical ascent and descent.
- ▶ Tested as per EN 1498.
- ▶ Spreader Bar available as optional accessory.



Easy Seat

Ref. IMP004

"For details refer to page no. 34"



KARAM Respac Recovery Stretcher

KARAM provides an easy-to-use Respac Recovery Stretcher for safe carrying of the wounded.

The backpack able Karam Respac Recovery Stretcher has been configured as an extremely flexible rescue system useable in any context where patient transport is needed and particularly useful in morphologic and difficult climatic situations where a fast recovery is desired.



Call **KARAM** Safety Expert
for further advise
Toll Free No.: 1800 103 7085



Respac Recovery Stretcher Ref. PN 403

Salient Features:

- ▶ Inert to all conditions , body fluids & blood.
- ▶ Allows Safe carrying of the wounded.
- ▶ Easy to use and store.
- ▶ Combination of optimum support and function.
- ▶ Extremely flexible rescue system.
- ▶ Highly durable.
- ▶ Can be used both vertically as well as horizontally.

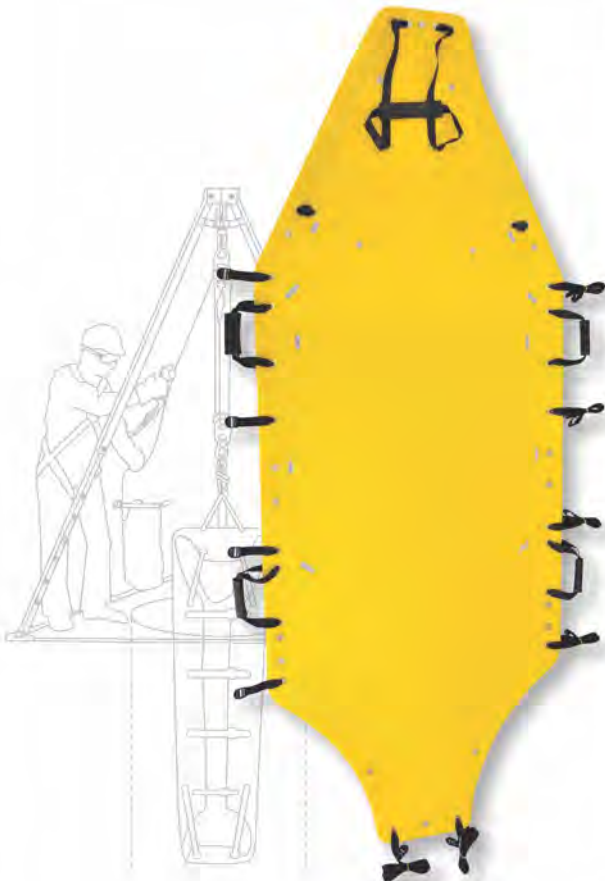

MODEL NO. PN 403

Maximum load	200Kg
Weight of device	5.5Kg
Total weight with bag and belts	8Kg

Loading Surface

Length	8 ft.
Width	3 ft.
Material	High Strength Polymer
Hooks (Material)	Alloy Steel

Rope

Length	9 m
Diameter	Dia 10 mm

Lifting Belts

Length	Feet zone 6.7 ft./ Head zone 6.4 ft.
Width	Feet zone 5mm/Head zone 5mm
Maximum load belts	3000Kg
Maximum load Stitching	2000Kg

Handles

Material	Polyester
Number of handles on every longitudinal side	2



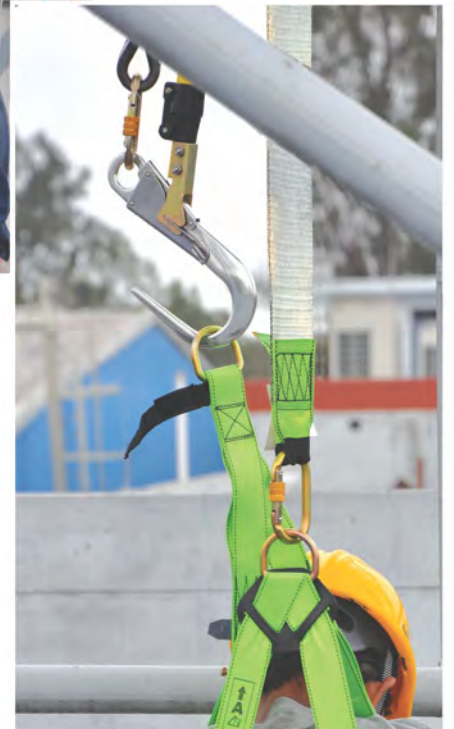

KARAM Launches a comprehensive range of customized KITS suitable for work specific use as per the standardized needs. The design of all the equipments used in a KARAM KITS is inspired by the user's safety and comfort requirements.

Self Contained Safety Kits



Maintenance & Window Cleaning Kit Ref. PN 651

This kit is meant to fulfill all the purposes and requirements of personnel engaged in maintenance jobs at height.



▶ Full Body harness
Ref. PN 56 (1 No.)



▶ Fall Arrester
Ref. PN 2000A (1 No.)



▶ Anchorage Rope
Ref. PN 950 (14mm)
(50mtr.)



▶ Tool Bag
Ref. BG 12 (1 No.)



▶ Kernmantle Rope
Ref. PN 950K



▶ Grip Descender
Ref. PN 401 (1 No.)



▶ Karabiner
Ref. PN 112 (3 Nos.)



▶ Anchorage Webbing Sling
Ref. PN 803 (2 No.)
(1.2mtr)



*Deluxe
Universal Kit Bag
Ref. BG 20*



Rescue Kit Ref. PN 652

KARAM Rescue Kit offers a complete and immediate solution for rescue of a victim of fall from height, as he lays suspended with his Fall Arrest Equipment

i Important :

Always inspect the KIT, seal it & stamp it " Safe for Use" so that it can be used immediately in case of an emergency.



▶ Work Positioning Lanyard
Ref. PN 242 (1 No.)



▶ Cows Tail
Ref. PN 401 (A)(0.5 mtr.)



▶ Knife (1 Nos.)



▶ Full Body harness
Ref. PN 56 (1 No.)



▶ Fall Arrester
Ref. PN 2000A (1 No.)



▶ Anchorage Rope
Ref. PN 950 (14mm)
(50mtr.)



**Deluxe
Universal Kit Bag
Ref. BG 20**

▶ Forked Lanyard
Ref. PN 351 (1 No.)



▶ Kernmantle Rope
Ref. PN 950K



▶ Grip Descender
Ref. PN 401 (1 No.)



▶ Karabiner
Ref. PN 112 (3 Nos.)



▶ Anchorage Webbing Sling
Ref. PN 803 (2 No.)
(1.2mtr)



Click on <http://karam.in/videos/> to know more, or scan the QR code alongside



Call **KARAM** Safety Expert
for further advise
Toll Free No.: 1800 103 7085



Tower Kit Ref. PN 653

This Kit is designed for the personnel engaged in working on high rise tower with an extra facility of bigger Hooks & easily adjustable Lanyards to suit the requirement of the working individual.



Tower Kit Ref. PN 653

▶ Full Body harness
Ref. PN 56 (1 No.)



▶ Fall Arrester
Ref. PN 2000A (1 No.)



▶ Work Positioning Lanyard
Ref. PN 242 (1 No.)



▶ Forked Lanyard
Permanently Attached
Ref. PN 351 (1 No.)



**Deluxe
Universal Kit Bag
Ref. BG 20**



▶ Tool Bag
Ref. BG 12 (1 No.)



▶ Anchorage Line
Ref. PN 950 (50 mtr.)





Confined Space Entry Kit with Tripod Ref. PN 654

This Kit is meant for personnel who are required to move into and for retrieval of personnel from Confined Spaces.



Confined Space Entry Kit with Tripod Ref. PN 654

▶ Full Body harness
Ref. PN 56 (1 No.)



▶ Tripod
Ref. PN 800 (1 No.)



▶ Winch
Ref. PN 801 (1 No.)



▶ Retractable
Fall Arrester Block
Ref. PCGS 10 (1 No.)



**Kit Bag
Ref. PN 904 (7ft) (BL)**



Call **KARAM** Safety Expert
for further advise
Toll Free No.: 1800 103 7085



Confined Space Entry Kit with K-Pod Ref. PN 655

This Kit is meant for personnel who are required to move into confined spaces, using the KARAM Cantilever K-Pod.



Confined Space Entry Kit with K-Pod Ref. PN 655

Full Body harness
Ref. PN 56 (1 No.)



KARAM Cantilever K-Pod
Ref. PN 900 (1 No.)



Winch
Ref. PN 801 (1 No.)



Retractable Fall Arrester Block
Ref. PCGS 10 (1 No.)



Call **KARAM** Safety Expert
for further advise
Toll Free No.: 1800 103 7085



**Kit Bag
Ref. PN 904 (7ft) (BL)**



New

Seize'em™

Rescue Kit
by **KARAM**

Ref. PN 661

SELF CONTAINED SAFETY KITS

KARAM introduces Seize'em Rescue Kit specifically designed for Rescuing a suspended casualty from Fall Arrest Lanyards, Rope Safety Lines & Fall Arrest Blocks, all possible from a point of safety.

The Kit comes complete with a Full Body Harness (PN 56), Steel Single Pulley (AP 002), Steel Karabiner (PN 113), Kernmantle Rope (PN 950K), Alluminium Double Pulley (AP 013), Rope Clamp (PN 402), Anchorage Webbing Sling (PN 803) & a Sturdy Bag (BG 20) with Sling for easy carrying.

The Kit is provided with a 3m with Telescopic Pole for extension to the fall victim, and hence does not require the rescuer to descend to the victim.



Seize'em Rescue Kit Ref. PN 661

▶ Full Body harness
Ref. PN 56 (1 No.)



▶ Aluminium Double Pulley
Double Side Attachment
Ref. AP 013 (2 No.)



▶ Kernmantle Rope
Ref. PN 950K (50 mtrs.)



▶ Aluminium Rebar
Hook Ref. PN 136



Length 3.0 m

▶ Telescopic Pole
Ref. PN 820



▶ Rope Clamp (Right or Left)
Ref. PN 402



**Deluxe
Universal Kit Bag
Ref. BG 20**



▶ Anchorage Webbing Sling
Ref. PN 803 (1 No.)
(1.2mtr)



▶ Steel Quarter Turn-locking
Karabiner
Ref. PN 113 (4 No.)



Click on <http://karam.in/videos/> to know more,
or scan the QR code alongside







Head Protection is required in almost every industry where there is a risk of being injured from falling objects or when working in areas of restricted head space.

The KARAM safety range of Safety Helmets offers the combination of exceptional comfort, simple integration of additional personal protective equipment and modern stylish design.

KARAM range of Safety Helmets is a testimony to a service that has constantly evolved to provide the finest in Head Protection to personnel working under most challenging environments.

Head Protection

KARAM range of Safety Helmet comes with plethora of features that not only offer the protection intended, but also with the comfort and design that ensures usage for long working hours.

PERFORMANCE & PROTECTION

Prepared for real life harsh industrial conditions, KARAM Safety Helmets Minimize and effectively disperse the impact forces.

EXTENSIVE PPE CONNECTIVITY

Quickly adaptable in field to changing industrial hazards, KARAM Safety Helmets are designed seamlessly protects users in combination with eye, face and Hearing Protection.

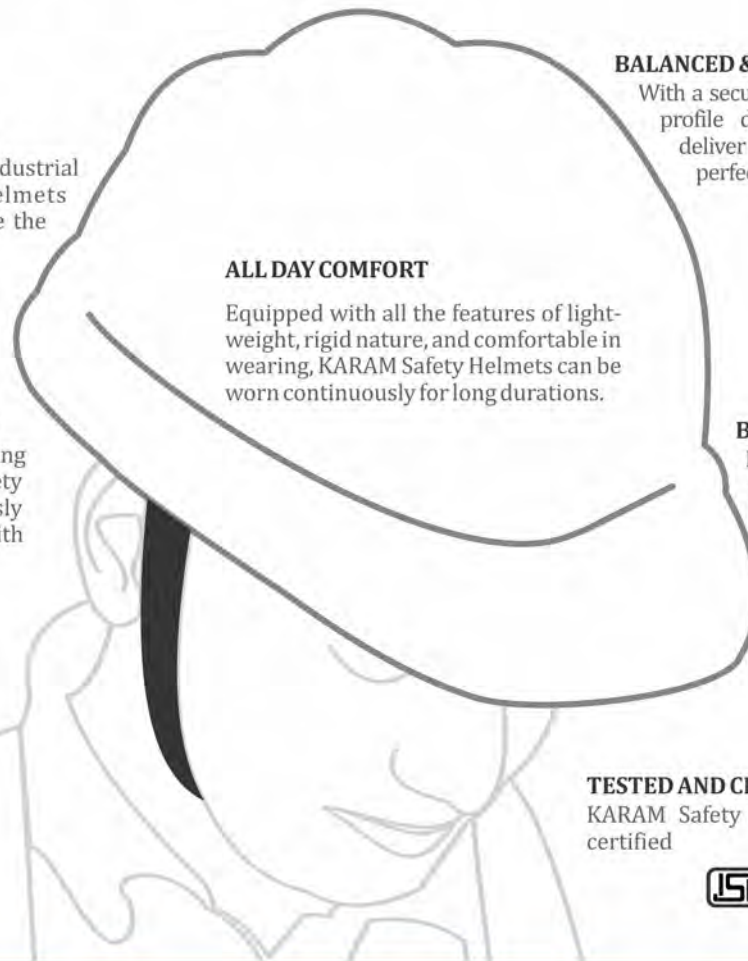

BALANCED & STABLE

With a secure head harness and a low profile designs; KARAM Helmets deliver maximum stability and perfect balance.

ALL DAY COMFORT

Equipped with all the features of light-weight, rigid nature, and comfortable in wearing, KARAM Safety Helmets can be worn continuously for long durations.

BUILT TO LAST

Manufactured from virgin premium grade, UV stabilized Polymers with no regrind; KARAM Safety Helmets are built to withstand the toughest of environments.

TESTED AND CERTIFIED

KARAM Safety Helmets are tested and certified



KARAM Safety Helmets can be fitted with a variety of additional Personal Protective Equipment such as:



Helmet Mountable Ear Defenders



Welding Screens



Polycarbonate Visors

The Helmet inner Harness is available in option of webbing and polymer as per customer need.

BRANDING SERVICES: KARAM Safety Helmets are an ideal product to display your company logo upon. With large branding areas and multi positions logos can be printed that offers a professional corporate identity.



Call **KARAM** Safety Expert
for further advise
Toll Free No.: 1800 103 7085



New

Shelblast by **KARAM**



STURDY & STYLISH DESIGN for EXCELLENT HEAD PROTECTION!

This **HIGH QUALITY PRODUCT** provides protection against impact, while giving special attention at the design that ensures maximum Visibility and wearer Comfort.

Conforms to EN 397:2012

The **Shelblast** with **FEATURES LIKE NEVER BEFORE!!**



Made of High density Polyethylene

Reinforced Ribs profile for better impact resistance

Protective Peak

Comes with a **Ventilated Slots** which can be opened/ closed with the help of a shutter to prevent any rain water seepage.

Provided with side slots for fitting face and hearing accessories

Unique Rain Management System which effectively manages the rain to reduce the flow of water down the neck.

Extended Nape for extra impact protection to the user's neck.



Has increased vertical clearance, along with the crown-cooling vents for increased airflow. Ideal for hot working atmosphere.

Shelblast with protective 'PEAK', for use in **GENERAL INDUSTRY**
Ref. PN 541



New

**KARAM offers the Shelblast in a new
‘Peak-less’ Design**

Equipped with all the features of the Shelblast, this Peak-less Helmet is ideal for Head Protection during climbing up or down a Tower/ Ladder.

Ref. PN 545

Additional Features offered by KARAM Shelblast

→ Replaceable Chin Strap – Easily detachable Clamps enables easy replacement of Chin Strap.



→ Sweat Band of KARAM Shelblast Helmet is made of material which is highly Sweat absorbent, cushioned, dermatologically tested, anti – allergic, skin – friendly and anti – skin – irritant. It is also easily replaceable.



KARAM SHELBLAST is offered in the following variants. You may choose the Shelblast with Head-band adjustment and chin-strap as per your need.



Shelblast Chin Strap is provided in two variants:-



Provided with Chin cup for additional comfort



Chin Strap with adjustable Slider Buckle.



Sheltek

KARAM 'Sheltek' range of Helmets, an evolutionary engineered product which has been specially designed with superior features and high impact resistance.
 CE certified and conforms to EN 397:2012, ISI and DGMS
 All Sheltek are provided with 4 corrugations on outer shell which gives increased impact resistant quality.

KARAM Sheltek is a specially designed Industrial Safety Helmet with superior features and High Impact Resistance- Sheltek PN 561 & PN 581.

The Sheltek provides the finest levels of comfort to the user and comes with the following features :

- ▶ Unique 6-point cradle for reduction of point impact
- ▶ Special grade Head-band made of fabric that conforms to EN 340:2003
- ▶ Comes with a manual type adjustment to allow easy adjustment.
- ▶ Has increased vertical clearance for optimum Shock Absorbtion
- ▶ Nape-type adjustment for better and easy fit.
- ▶ Also conforms to **ISI, DGMS & CE**
- ▶ Equipped with removable Chin Strap.

Ref. PN 561

Made of High density Polymer

Quadro Corrugation for enhanced strength

The Helmet inner Harness is available in options of webbing and polymer as per customer need.



6-Point Cradle

Adjustable Nape-Band



Provided with Side Slots for fitting face and hearing accessories

Extended Nape for extra impact protection to the user's neck.

Manual type adjustment to suit most head sizes

Adjustable Chin-Strap for universal adjustment

Features of the unique Head-Band and Foam

- ▶ Allows good absorption of sweat.
- ▶ Maintains a neutral pH, hence does not cause skin irritation.
- ▶ Does not stain the skin through any release of colour.
- ▶ Is safe and not known to cause any harmful effects to the skin.

Ref. PN 581

WITH RATCHET TYPE ADJUSTMENT

- ▶ Ratchet type adjustment for Comfort & Better Grip.
- ▶ Comes with special grade Head- band made of fabric that conforms to EN 340:2003
- ▶ Equipped with removal Chin Strap.
- ▶ Provided with side slots for fitting face and hearing protection accessories.



Call **KARAM** Safety Expert
 for further advise
 Toll Free No.: 1800 103 7085

Shelmet

KARAM introduces 'Shelmet' range of Helmets, specially designed to meet the demanding requirements of both construction and industrial needs with both safety and comfort in mind. All Shelmet are provided with **Triple Corrugations** on outer shell which gives increased impact resistant quality. Conforms to **ISI & DGMS** standards which can be used in the toughest of conditions to provide the highest level of safety.

Ref. PN 501

Made of specially formulated Polymer

Triple Corrugation for enhanced strength.



Comes with **Manual Adjustment** to suit most head sizes.



The **Head band** is made of non-irritant and soft fabric to provide maximum comfort to the user.



Provided with **Side Slots** for fitting face and hearing protection accessories.

Adjustable Chin Strap



The four point attachment Cradle within the shell has a unique angular placement to provide optimum shock absorption.



Ref. PN 521

KARAM Shelmet with Ratchet-Type Adjustment

The Ratchet adjustment can be set to the correct head size by pushing the hand-wheel in and turning it. The adjustment position is locked when the hand-wheel is released.

Conforms to **IS 2925:1984**

The KARAM Helmets- Shelblast, Sheltek and Shelmat are provided in a vast range of colours which are stabilized against ultra violet degradation through appropriate UV stabilizers. KARAM also provides a unique Auto-Glow Model which has a distinctive property of Photo-Luminescence and hence glows even in the dark.

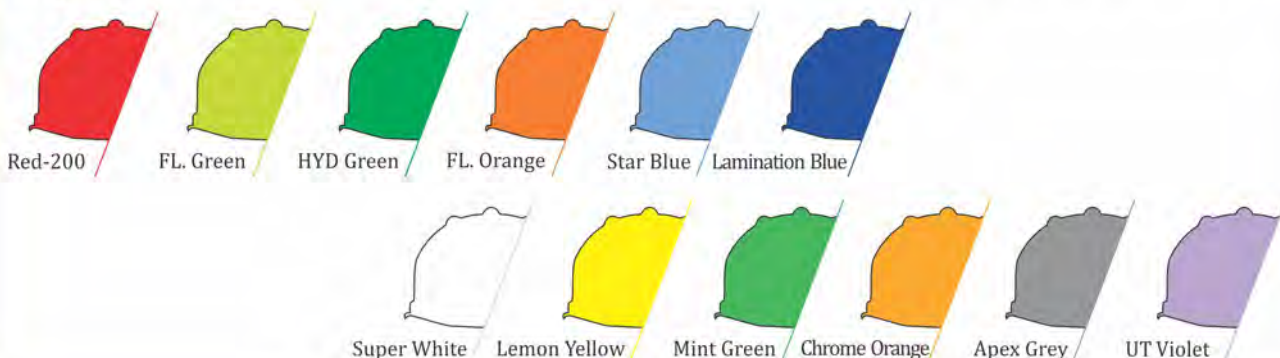

The Helmet inner Harness is available in options of webbing and polymer as per customer need.



KARAM®

Safety Helmets

Are subjected to various **Different Tests**

As per the Requirement of **IS & CE** Norms,

in The **Helmet Testing Laboratory**

at **KARAM.**

TEST FOR SHOCK ABSORPTION



This test is performed on the helmet after conditioning it at different temperatures as defined in the relevant Norms. It is important to ensure that the helmet limits the impact of force transmitted to a head form to within the specified limits mentioned in the Norms.

FLAME RESISTANCE TEST

KARAM Helmets are also tested for Flame Resistance as per both IS and EN Norms.

VISUAL CHECK FOR FUNCTIONALITY & PERFORMANCE

Carried out on all the Helmets to ensure their proper finish and functionality.

TEST FOR PENETRATION RESISTANCE



The test ensures that the helmet withstands a specified penetration force, and does not show signs of piercing, denting or failure of any of its integral parts.

WATER ANSORPTION TEST

This test is carried out on KARAM Helmets to ensure that there is minimal water absorption by the helmet under specified test conditions.



Call **KARAM** Safety Expert
for further advise
Toll Free No.: 1800 103 7085



KARAM offers an exhaustive range of Welding Shields & Face Protectors that not only offers protection against.

KARAM Welding Shields & Face Protectors are specifically designed to help protect the wearer eyes from the harmful radiation including visible light, UV/IR radiation resulting from welding processes.

Extremely light in weight to facilitate maximum comfort as well as protection during Welding operations.

A vertical strip on the left side of the page shows a close-up of bright orange and yellow sparks from a welding process, set against a dark background.

WINNING EDGE OF KARAM WELDING SHIELDS

- ▶ The design of KARAM Welding Shields is such that it **minimizes the Carbon Dioxide built up** in the respiratory area.
- ▶ The lower part of the Welding Shields are designed such that the **Welding fumes are guided away** from the respiratory area.
- ▶ KARAM Welding Shields **have a convex surface** which allows the metal **droplets to roll-off** readily in overhead welding situations.
- ▶ They **have low thermal conductivity** hence do not heat up resulting in more comfortable wear.
- ▶ KARAM Welding Shields are **free from any sharp edges**.
- ▶ The **Field of Vision is unobstructed** by the boundaries of the filter holder.
- ▶ Headband is broad enough to **suit most head sizes**.
- ▶ **Easy to replace Filters** without use of any special tools.
- ▶ All inside surfaces are **Matt finish**, there by reducing any glares.
- ▶ The Harness holds the Shield in the correct position when properly adjusted.
- ▶ KARAM Welding Shields are specially designed to **adjust and fit the wearer's head** in both circumference, without causing a undue pressure.
- ▶ The **Harness** of the Welding Shields are **easily replaceable**.

Welding & Face Protection



KARAM Welding Shields

This Welding Helmet is extremely light in weight, providing comfort as well as protection during welding operations.

It has a Flip Front Window which makes it easy for normal viewing even when the operations are not on and is provided with a protective lens made of clear High Impact Resistant Polycarbonate.

Conforms to EN 175 FCC and EN 175:1994

Welding Helmet Ref. ES 61

Headgear- made of High strength Nylon

Ratchet Adjustment

Size of Window : 10cm x 4.4cm

Polypropylene Impact Resistant Shell



Liftable Welding Lens to allow clear view, while restricting harmful dust particles.

Protective Lens made of Clear high impact Resistant Polycarbonate.
Conforming to EN 166 and ANSI Z 87.1

Conforming to EN 175F

KARAM WELDING SHIELD

The features include a Polypropylene Impact Resistant Shell with a high strength nylon Ratchet headgear.
The Welding Shield is CE marked.

The IR lens is provided extra as per choice:

- ▶ ES 04/5: is an IR 5 lens
- ▶ ES 04/11: is an IR 11 lens
- ▶ Accessories - ES61(01) Inner Harness



The Head band of the Harness has 4 adjustment positions for adjustment of the stop angle of the Shield.



The height of the shell is also made adjustable by means of an adjustment provided on the Harness above the head.



The Ratchet adjustment at the nape allows easy adjustment of the Harness.

It has a horizontal adjustment feature to provide the user the comfort to move the shell closer or further from the face.

FEATURES OF THE HEAD FITTING HARNESS OF ES 61

The Head band is provided with an Anti-Sweat comfort pad for increased comfort.



Helmet Mountable Welding Shield

Ref. ES 71



HELMET ATTACHABLE WELDING SHIELD

Features:

- ▶ When fitted, it will protect the wearer's face due to the special wrap-around design.
- ▶ It fits most standard Safety Helmets which have a 30 mm slot & are best used with KARAM Helmets.
- ▶ Easy to use in a variety of work situations
- ▶ This Welding Shield is certified to be used only in conjunction with a Safety Helmet, and should not be used independently.
- ▶ IR 5 or IR 11 Lens can be inserted between two protective lens made of clear high impact resistant Polycarbonate, conforming to EN 166 and ANSI Z87.1
- ▶ Conforms to EN 175 and ANSI Z 87.1



Can be fitted on KARAM Helmets, Shelmet, Sheltek & Shelblast



Call **KARAM** Safety Expert
for further advise
Toll Free No.: 1800 103 7085



Auto Darkening Welding Helmet

Ref. ES 81

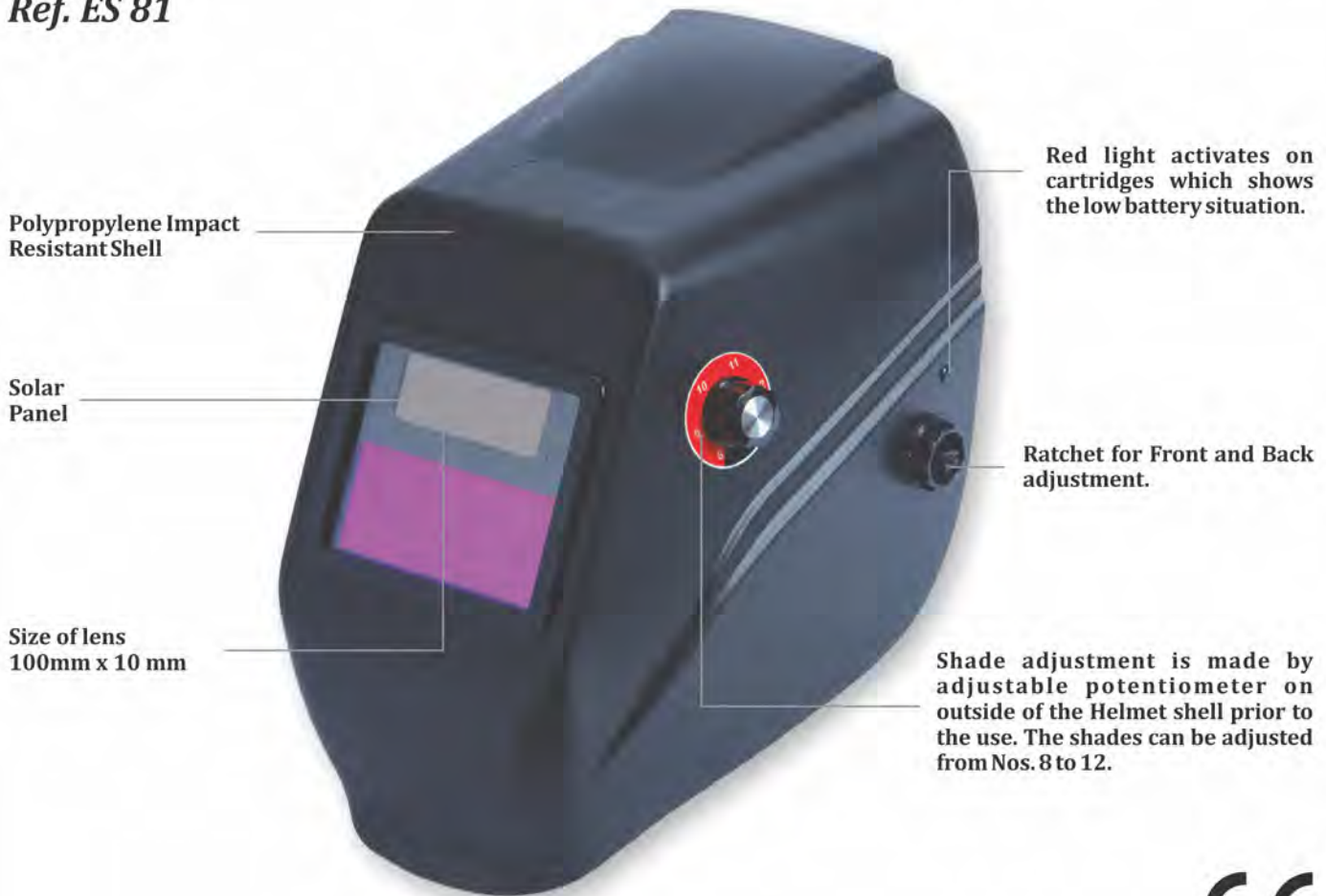

AUTO DARKENING WELDING SHIELD

This Welding Helmet has a High impact resistant Polypropylene shell and has a unique Auto Darkening feature.

Sensors are provided on the front of the lens which reacts the moment the welding arc is struck and cause the filter to darken. The filter switches back to the light shade as soon as the welding has stopped. Protection from UV/IR radiations are continuous in all stages of the filter even when the battery is completely discharged, the welder still remains protected against harmful radiation accordingly to the darkest shade of the filter (shade 12).

It can be fitted with a variety of harnesses, and it conforms to EN 175, EN 379 and also meets ANSI Z.87.

Features and Benefits of Face Shield

- ▶ Size of lens 100mm x 10 mm.
- ▶ There are indicative buttons on the lens for various actions.
- ▶ Press test button before each use.
- ▶ Cartridge offers complete Ultra Violet/ Infrared protection lens means most indoor as well as outdoor welding requirements & can be used for arc as well as TIG welding operations.
- ▶ Helps in eliminating welder fatigue.
- ▶ Depicts Low battery situation.
- ▶ The batteries can be easily replaced once the following indications appears
- ▶ Red light on the cartridge is activated.
- ▶ Lens is in constant dark mode.



Comes with all the Adjustment Harness features as provided in Welding Shield ES 61.

Face Shields

KARAM Visors can be mounted onto the KARAM Safety Helmets (Shelmet, Sheltek, Shelblast) to allow attachment of a range of Face shields. The high quality product provides protection against impacts from the front and side.



Features and Benefits of Face Shield

- ▶ A wide range of visors and Face Shield available for many Forestry and Industrial applications.
- ▶ Offers a wide field of view.
- ▶ Designed to attach to KARAM wide range of Helmets Earmuffs with Helmet Adapter.



KARAM Face Shields



The KARAM Face Shield is economical and suitable for the following industries

Ref. ES 51 (01)

- ▶ Metal cutting operation
- ▶ Spray painting
- ▶ Carpentering
- ▶ Petroleum industry
- ▶ Chemical industry
- ▶ Grinding
- ▶ Processing

- ▶ Electric welding
- ▶ Iron and steel industry, etc.

Ref. ES 51 (02)

- ▶ Flying Woodchips
- ▶ Grinding
- ▶ Furnaces
- ▶ Grass Trimming

The special Adaptor provided offers easy mounting of the Face Shield assembly over the KARAM Shelmet, hence offering maximum protection.



Call **KARAM** Safety Expert
 for further advise
 Toll Free No.: 1800 103 7085





KARAM brings to you complete range of Safety spectacles that are perfect combination of Comfort and Safety. KARAM has introduced a revolutionary range of Safety Spectacles which are self adjustable to individual head sizes, delivering noticeable higher levels of personal comfort particularly at Industrial and Welding works. KARAM range of Safety Spectacles are CE certified and conforms to the standard laid down in EN 166:2001.

Safety Spectacles

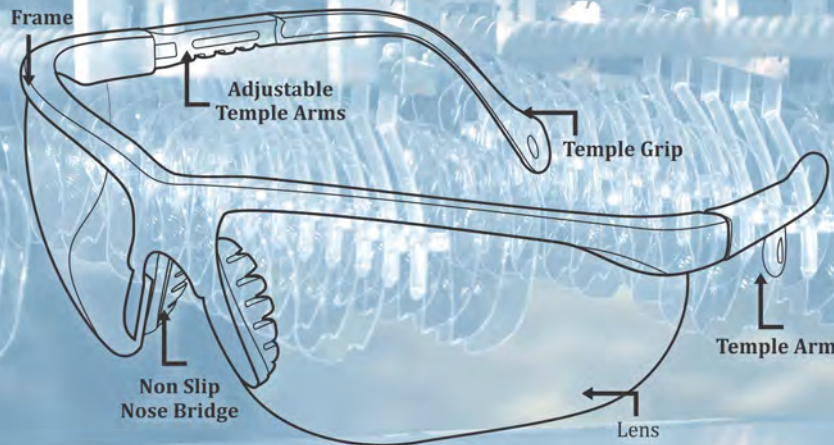

KARAM WINNING EDGE...



Scratch-resistant Lenses- will maintain the clear vision

Anti-Static Lenses

Indoor/Outdoor Lenses- For use in all conditions of light modulations

Models of Spectacles that fit over the prescription glasses as well

Sleek and fashionable, offering all comfort features

Redefining the Ergonomics- Adjustable Models to fit one and all

Anti-Fog Lenses- To make sure that no fogging appears on those models of Spectacles that seal the face area

“Critical Tests Through Which KARAM Safety Spectacles Pass”

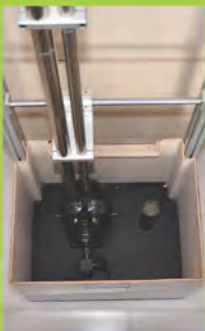

Drop Ball Impact Test



High Velocity Impact Test



Transmittance Test



Prismatic Refractive Power



Astigmatic Refractive power



Stress View Test



Construction Worker's Choice Conforms to EN 166:2001, ANSI Z 87.1-2010



Ref. ES 001

- ▶ Made with polycarbonate, Safety Spectacle ES001 offers lighter, exceptional Impact & Splash protection with excellent vision.
- ▶ An Ultra-light weight model and equipped with a Flexible Frame which virtually ensures a close snug fit on both large and small faces, Safety Spectacle ES 001 offers the highest level of eye protection against high speed particles.

Area of Use

- ▶ Construction Sites; areas where sand and large dust particles are blowing at high Speed.
- ▶ Metal - Processing Shops.

Available Lens Option

- ▶ Clear
- ▶ Smoked



Ref. ES 001 (Clear)



Lens Features

- ▶ Optical Class 1
- ▶ Material : Polycarbonate
- ▶ Hard-coated lens for Scratch Resistance
- ▶ Smoked lens model also provides optimum protection against harmful UV radiation
- ▶ High Impact resistant
- ▶ Tested at elevated temperature
- ▶ Lens scale number : 3-1.2 (clear)
- ▶ Lens scale number : 5-2.5 (smoked)



Ref. ES 001 (Smoked)



Special Features

- ▶ Extremely light weight, weighing only about 26 gms, thus providing extreme comfort.
- ▶ Wrap-around design for better coverage.
- ▶ Provided with a Watch on temple to display month & year of manufacturing
- ▶ Tested for disinfection.
- ▶ Increased robustness
- ▶ Resistant to corrosion.
- ▶ Resistant to ignition.
- ▶ Optically tested
- ▶ Flame resistant



Call **KARAM** Safety Expert for further advise
Toll Free No.: 1800 103 7085

Gas Welder's Choice

Conforms to EN 166:2001



Ref. ES 003

- ▶ Containing all the inherent design, sporty and comfort features of the ES 003 has an additional protective quality to offer. It is fitted with a special IR-5 lens, making it an ideal choice for protection to the eyes during gas welding operations.

Area of Use

- ▶ Areas involving gas welding operations
- ▶ Areas where there is molten metal; furnaces, etc.

Available Lens Option

- ▶ Single lens option using IR-5 lens



Ref. ES 003 (IR-5)



Lens Features

- ▶ Optical class-1, IR-5 lens
- ▶ Hard-coated lens for Scratch-Resistance
- ▶ Polycarbonate lens integrating the side-shields for perfect protection.
- ▶ Lens material: Polycarbonate
- ▶ Lens scale number: 4-5

Special Features

- ▶ Temple grips equipped with soft cushioning pads, making it more comfortable for all day use.
- ▶ Adjustable temple length to customize fit on the user's head. Length adjustable within a range of 13mm.
- ▶ Temple/ Side Arms capable of tilting within a wide angle range (upto 60 degree) there by adjusting to provide the best possible fit.
- ▶ Resistance to corrosion
- ▶ Universal Nose bridge
- ▶ Pivoting Navy Blue Nylon frame

Electric- Arc Welder's Choice

Conforms to EN 166:2002, EN 175:1997 & ANZI Z 87.1-2010



Ref. ES 004

- ▶ Equipped with a special IR-11 lens and a broad, soft PVC body which provides the wearer a wider protective sealing area, the ES 004 is an ideal choice for a variety of electric arc welders.

Area of Use

- ▶ Best suited for electric arc welding, mig, tig and other electrical welding operations

Lens Features

- ▶ IR-11 lens
- ▶ Lens material Polycarbonate
- ▶ Hard-coated for Scratch-Resistance
- ▶ High Impact Resistant
- ▶ Comes with Lens Replaceable feature

Special Features

- ▶ It has a wide soft PVC body which provides the wearer excellent comfort.
- ▶ It is provided with a flip-up lens window to enable clear vision during those times while welding operation is not in progress.
- ▶ It is provided with Six Indirect Ventilation Caps two on top, two in bottom and one each in sides.
- ▶ It has a fully adjustable elastic head- band for a snug fit.
- ▶ High impact resistant
- ▶ Comes with Lens Replaceable feature.



Ref. ES 004





Executive's Choice *Conforms to EN 166:2001, ANSI Z 87.1-2010*



Ref. ES 005

- ▶ Made with Nylon frame and Polycarbonate lens which offers lighter, exceptional impact and splash protection with excellent vision when it comes to fashion and styling, combined with ultimate eye safety, the ES 005 becomes an ideal choice for the wearer.

Area of Use

- ▶ Construction sites; areas where sand and large dust particles are blowing at high speed.
- ▶ Metal-processing shops.

Available Lens Option

- ▶ Clear
- ▶ Smoked



Ref. ES 005 (Clear)



Lens Features

- ▶ Optical Class 1
- ▶ Hard-coated lens for Scratch Resistance
- ▶ Smoked lens model also provides optimum protection against harmful UV radiation.
- ▶ High Impact resistant
- ▶ Tested at elevated temperature
- ▶ Lens material- Polycarbonate
- ▶ Lens scale number: 3-1.2 (clear)
- ▶ Lens scale number: 5-2.5 (smoked)



Ref. ES 005 (Smoked)



Special Features

- ▶ Combines Safety with a fashionable look, enhancing user compliance
- ▶ Adjustable temple length to customize the fit on the user's head. Length adjustable within a range of 15mm.
- ▶ Equipped with specially designed flexible soft nose-pad to provide extra comfort.
- ▶ Tested for disinfection.
- ▶ Increased robustness
- ▶ Resistant to corrosion.
- ▶ Resistant to ignition.
- ▶ Optically tested
- ▶ Flame resistant
- ▶ UV resistant



Call **KARAM** Safety Expert
for further advise
Toll Free No.: 1800 103 7085

Indoor/Outdoor User's Choice

Conforms to EN 166:2001



Ref. ES 006

- Designed for both Indoor as well as Outdoor usage, and fitted with light mirror coated lens, the ES 006 is an ultimate symbol of fashion and styling, coupled with complete eye safety.

Area of Use

- Used in areas where the light conditions change from normal to bright.

Available Lens Option

- Light mirror coated lens, also known as the Indoor/Outdoor lens
- Also available in clear lens



Ref. ES 006
(Indoor/Outdoor)



Lens Features

- Optical Class 1
- Hard-coated lens for Scratch Resistance
- Lens Scale Number: 2- 1.2 (clear)
- Lens Scale Number: 5- 1.7 (Indoor/Outdoor)
- Material: Polycarbonate
- Hard-coated for Scratch Resistance

Special Features

- Combines safety with a fashionable look, enhancing user compliance
- Adjustable temple length to customize the fit on the user's head. Length adjustable within a range of 14mm.
- Equipped with specially designed flexible soft nose-pad to provide extra comfort.



Ref. ES 006 (Clear)



Prescription-Glasses Wearer's Choice

Conforms to EN 166:2001
& ANSI Z 87.1-2010



Ref. ES 007

- To provide safety to those who cannot directly put on a safety eye wear, as they have to wear prescription spectacles, the ES 007 easily fits over the prescription frames.

Area of Use

- Construction sites; areas where sand and large dust particles are blowing at high speed.
- Metal processing shops

Available Lens Option

- Clear



Ref. ES 007 (Clear)



Lens Features

- Optical Class 1
- Hard coated lens for Scratch Resistance
- Lens material- 100% Polycarbonate
- Lens Scale Number: 3- 1.2 (clear)

Special Features

- It can easily fit over most prescription spectacles
- Comes with adjustable temples for better fitting to the wearer



Chemical Environment User's Choice

Conforms to
EN 166:2001 & ANSI Z 87.1-2010



Ref. ES 008



- ▶ Providing fail-proof protection against liquid and chemical splashes, the ES 008 comes with a unique wrap-around design and a specialized anti-fog lens.

Area of Use

- ▶ Areas exposed to splashes of chemicals.

Available Lens Option

- ▶ Clear
- ▶ Smoked

Lens Features

- ▶ Anti-fog coating on the lens
- ▶ Optical Class 1

Special Features

- ▶ It has a soft and wide PVC casing around the rim to ensure 100% sealing of the eyes against chemical and liquid splashes.
- ▶ It is provided with indirect ventilation slits on both the top and the bottom parts of the rim to allow for air circulation.
- ▶ It has a fully adjustable elastic head-band for a snug fit.



Ref. ES 008 (Clear)



Ref. ES 008 (Smoked)



Chemical Environment User's Choice

Conforms to
EN 166:2001 & ANSI Z 87.1-2010



Ref. ES 009



- ▶ KARAM introduces a new economy range eye wear model to keep your eyes safe at all times from Chemical and Liquid splashes in such environment.

Area of Use

- ▶ Areas exposed to splashes of chemicals.

Available Lens Option

- ▶ Single Clear
- ▶ Single Smoked

Lens Features

- ▶ Anti-fog coating on the lens
- ▶ Optical class 1

Special Features

- ▶ Has a soft PVC shroud which imparts increased comfort to the wearer.
- ▶ Lens is made of hard-coated Polycarbonate which makes it completely Scratch-Resistant.
- ▶ UV resistance of 99.9% for range 200 - 400nm.
- ▶ The frame has 4 ventilation caps, 2 on the top and 2 at the bottom of the frame. These are special one-way vents which allow air movement while keeping harmful liquid-splashes out.
- ▶ Comes with an adjustable elastic band.
- ▶ Light weight, weighing less than 70 grams.



Ref. ES 009 (Clear)



Ref. ES 009 (Smoked)



Worker's Choice

Conforms to EN 166:2001-2010



Ref. ES 010

- ▶ A Unique combination of sporty look & an extended comfort, this range offers the highest level of eye protection against high speed particles. It comes in two lens shades - Clear lens & Smoked lens.

Area of Use

- ▶ Industrial, Construction sites & areas where sand & large dust particles are blowing at high speed.

Available Lens Option

- ▶ Clear
- ▶ Smoked
- ▶ Antifog

Ref. ES 010 (Clear)



Lens Features

- ▶ Optical Class-1
- ▶ Low Energy Impact Resistance
- ▶ Scratch Resistant Lens
- ▶ Lens Scale Number : 3-1.2 (Clear)
- ▶ Lens Scale Number : 5-3.1 (Smoked)

Ref. ES 010 (Smoked)



Special Features

- ▶ Light weight Spectacles, thus providing long lasting comfort.
- ▶ Wrap around design for better coverage.
- ▶ The clear lens spectacles comes with smart electric blue temples while the smoked spectacles comes with blended black temples, hence giving an extremely stylish look.
- ▶ 100% Polycarbonate lens. The smoked lens model filters out more than 99.9% of harmful UV light.
- ▶ The lens is specially Hard-coated for Scratch-Resistance.
- ▶ Provided with a watch on temple to display month and year of manufacturing.
- ▶ It is best suited for protection against low impact energy from high speed particles at extreme temperatures.



Call **KARAM** Safety Expert
for further advise
Toll Free No.: 1800 103 7085





Premium Choice Conforms to EN 166 : 2001 & ANSI Z 87.1-2010



Ref. ES 012

- ▶ Smart Executive Safety Spectacles with quick release design of temples. It combines the advantages of both spectacles and goggles and comes in two lens shades-Clear lens & Mirror finish lens.

Area of Use

- ▶ Manufacturing, Warehouse, Assembly, Lab, Medical, Construction, Woodworking, etc.

Available Lens Option

- ▶ Specialized Anti Fog Clear & Mirror Finish Lens

Ref. ES 012 (Antifog Clear)



Lens Features

- ▶ Optical Class-1
- ▶ Low Energy Impact Resistance
- ▶ Scratch Resistant Lens
- ▶ Lens Scale No : 2-1.2 (Clear)

Special Features

- ▶ Has a soft foam Padding frame for cushion fit & dust proof protection.
- ▶ Comes with Quick release design which allows user to change the temple/elastic band easily.
- ▶ Fully wrap around design with 8 base Polycarbonate & Specialized Anti-fog coating on the lens. Has superior impact protection & coverage.
- ▶ Unique temple design & dual injection temple tips (Polycarbonate & TPE) for all day comfort.
- ▶ Has outstanding seal with Splash Proof Protection.
- ▶ 100% Polycarbonate lens. The Mirror finish lens model filters out more than 99.9% of harmful UV light.
- ▶ Comes with an Elastic band which is fully adjustable & non-skin Irritant.

Ref. ES 012 (Mirror Finish)



Dual Material Temple having a Quick-release design for easy detachment



Non Skin Irritant Elastic Band (provided within)

Smart Choice

Conforms to EN 166 : 2001 & ANSI Z 87.1-2010

Ref. ES 013

- ▶ Specially designed smart & fashionable Safety Spectacles... a perfect choice for both men & women.

Area of Use

- ▶ Industrial, Construction sites & in the areas where sand & large dust particles are blowing at high speed.

Available Lens Option

- ▶ Clear
- ▶ Smoked

Lens Features

- ▶ Optical Class-1
- ▶ Low Energy Impact Resistance
- ▶ Scratch Resistant Lens
- ▶ Lens Scale Number : 2-1.2 (Clear)
- ▶ Lens Scale Number : 5-2.5 (Smoked)

Special Features

- ▶ Light weight Spectacles, which resembles sunglasses & provides long lasting comfort to the user.
- ▶ Close-fitting, unitary front with dual I/O base curved lens offers wide and unobstructed vision.
- ▶ Dual-material temples for comfortable fit.
- ▶ Soft nosepiece; universal & snug fit.
- ▶ 100% Polycarbonate lens that filters out more than 99.9% of harmful UV radiation



Ref. ES 013 (Clear)



Ref. ES 013 (Smoked)



Worker's Choice

Conforms to EN 166 : 2001 & ANSI Z 87.1 - 2010

Ref. ES 014 (Clear)

- ▶ Made with Polycarbonate frame and Polycarbonate lens material which offers lighter, exceptional impact & splash protection with excellent vision

Area of Use

- ▶ Construction sites; areas where sand and large dust particles are blowing at high speed.
- ▶ Metal processing shops

Available Lens Option

- ▶ Clear



Ref. ES 014 (Clear)

Lens Features

- ▶ Optical Class 1
- ▶ Hard-coated lens for Scratch Resistance
- ▶ High Impact resistant
- ▶ Tested at elevated temperature
- ▶ Lens Material: Polycarbonate
- ▶ Lens scale number : -2-1.2 (clear)

Special Features

- ▶ Lens is made of hard-coated Polycarbonate which makes it completely Scratch-Resistant.
- ▶ UV resistance of 99.9% for range 200 - 400nm.
- ▶ Light weight, weighing 30 grams



Executive's Choice

Conforms to EN 166:2001 & ANZI 2-87.1-2010



Ref. ES 015

- ▶ Made with Nylon frame and Polycarbonate lens which offers lighter, exceptional Impact and Splash protection with excellent vision
- ▶ When it comes to fashion and styling, combined with ultimate eye safety, the ES 015 becomes an ideal choice for the wearer.

Area of Use

- ▶ Construction sites; areas where sand and large dust particles are blowing at high speed.
- ▶ Metal-processing shops.

Available Lens Option

- ▶ Clear



Ref. ES 015 (Clear)



Lens Features

- ▶ Optical Class 1
- ▶ Hard-coated lens for Scratch Resistance
- ▶ Smoked lens model also provides optimum protection against harmful UV radiation.
- ▶ Better Impact resistant
- ▶ Tested at elevated temperature
- ▶ Lens material- Polycarbonate
- ▶ Lens scale number : -2-1.2 (clear)



3 steps for
Temple Adjustability

Special Features

- ▶ Combines safety with a fashionable look, enhancing user compliance
- ▶ Adjustable temple length to customize the fit on the user's head. Length adjustable within a range of 15mm.
- ▶ Provided with a Watch on temple to display month & year of manufacturing.
- ▶ Tested for disinfection.
- ▶ Increased robustness
- ▶ Resistant to corrosion.
- ▶ Resistant to ignition.
- ▶ Optically tested
- ▶ Flame resistant



Call **KARAM** Safety Expert
for further advise
Toll Free No.: 1800 103 7085



Goggles with Mask and Tear Off Film

Conforms to EN 166:2001 & ANSI Z 87.1-2010



Ref. ES 016 (Clear)

- ▶ This Spectacle provides fail-proof protection against liquid and chemical splashes & comes with a unique wrap around acetate lens.

Area of Use

- ▶ Industrial Settings where protection against Chemical and Liquid Splashes/Molten Metal is required (especially where solvents are present in the environment Eg: Painting applications)
- ▶ Metal-processing shops.

Available Lens Option

- ▶ Clear

Ref. ES 016 (Clear)



Lens Features

- ▶ Optical Class 2
- ▶ Hard Coated (Scratch Resistant)
- ▶ Chemical Resistance Coated
- ▶ Anti-Static Coated

Special Features

- ▶ 99.9% UV Protection
- ▶ Resistance to Low Impact Energy of High Speed Particles
- ▶ Protection against Droplets and Splashes of Liquids
- ▶ No liquid enters the Ocular Area when sprayed with a Hand Operated Atomiser
- ▶ Sealed Fit with Head Band
- ▶ Offers Indirect Ventilation
- ▶ Can be used over Prescription Glasses
- ▶ Mask to Protect Nose and Mouth
- ▶ Tear Off Film to protect Acetate Lens



Ref. ES 016 (01)



Ref. ES 016 (02)



Ref. ES 016 (03)





KARAM also provides spectacles accessories on request.

Ref. ESA 01

The Spectacle Belt-Carrying Case
Ref. ESA 01

- ▶ Has a band at the rear which can be easily looped over the trouser-belt of the wearer. This enables the wearer to keep his Spectacles safe and handy at all times when not in use.
- ▶ The inner lining of the case is soft and hence prevents any scratches to be formed on the lens of the Spectacle.



The Case is also provided with a soft cotton Lens-Wipe, available in different colours











Ref. ESA 02

The Black Spectacle Neck-String
Ref. ESA 02

- ▶ Can be easily fitted to the temple-arms of the KARAM Spectacles and worn around the neck.



			
<p>Over Prescription Glasses</p>	<p>Side arm length multiple positions</p>	<p>No Image Distortion</p>	<p>Infra-Red Protection</p>
			
<p>High Impact Protection</p>	<p>Head Band Adjustable</p>	<p>Chemical Splash</p>	<p>Ultra-Violet Protection</p>

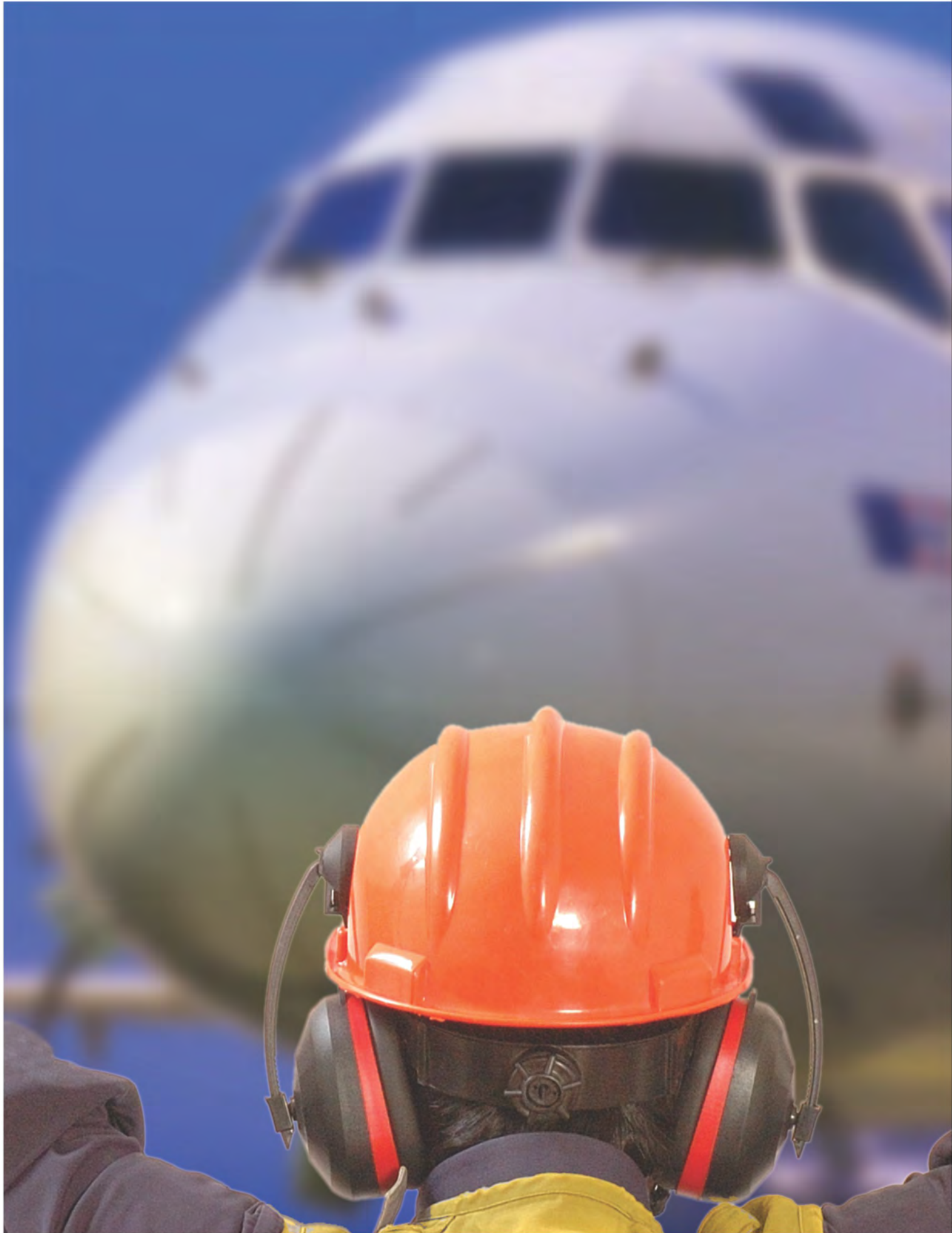



Ear Protection

KARAM offers a range of Ear-Protection equipment which provide appropriate attenuation of noise in various Industrial settings.

The KARAM Ear-plugs are an ideal choice for Ear-Protection during long hours of exposure to high decibel sound.

The KARAM Ear-Muffs are versatile, apt for usage during shorter duration of exposure, and come with different features, like- helmet-mountable, foldable, etc.



EP 01 (Uncorded)



EP 02 (Corded)



Disposable Foam Ear Plugs

Ref. EP 01 and EP 02

NRR 32 dB

SNR 37 dB

The very soft foam provides comfortable and close fitting seal against harmful noise.

- ▶ One size fits all Ear Canals.
- ▶ Made up of Non- Irritant and Allergy-free material.
- ▶ Uncorded in bright orange colour.
- ▶ Easy to insert correctly due to their tapered shape and moderate slow expansion rate.
- ▶ Corded in Fluorescent Orange colour.
- ▶ Also available in nylon & cotton cord.
- ▶ Complies EN 352-2:2002



RIGHT WAY TO WEAR EAR PLUG



EP 03 (Uncorded)



EP 04 (Corded)



Reusable Ear Plugs

Ref. EP 03 and EP 04

NRR 21 dB

SNR 31 dB

Suitable for protection against long term exposure to medium noise levels

- ▶ Washable and reusable.
- ▶ One size fits all Ear Canals.
- ▶ Special flange design for maximum comfort.
- ▶ Draped around the neck, the cotton corded ear plug rests secured with the user.
- ▶ Complies EN 352-2:2002, ANSI Z 3.19 & ANSI Z 12.6



EP 06 (Accessories)



EP 05 (Band)



Banded Replacable Foam Ear Plugs

Ref. EP 05 and EP 06

NRR 22 dB

SNR 31 dB

The EP 05 provided with hinged headband design allows to be worn in a various position; soft foam plug fits ear canal comfortable and provides excellent hearing protection.

- ▶ The band EP 05 is reusable and can be worn under the chin or behind neck with the special shaped Foam Ear Plugs EP 06.
- ▶ Band prevents Ear Plugs from touching dirty and contaminated surfaces.
- ▶ Plugs are available separately and are replaceable.
- ▶ One size fits all Ear Canals
- ▶ Complies to EN 352-2:2002



Hearing Protection must be right for you and your situation. For Safety, Productivity and Comfort, it must reduce noise by the right amount, not too little and not too much. KARAM provides solution for different individuals and application with a wide range of Earmuffs and Earplugs.

Ear Muff Classic

Ref. EP 21

NRR 23 dB

SNR 23 dB

- ▶ Light weight and extremely comfortable
- ▶ Special ABS Ear Cups for durability.
- ▶ Three position Adjustable.
- ▶ Soft cushioned pads for good seal against noise.
- ▶ Conforming to EN 352-1:1993.
- ▶ Recommended Areas: Airports, Excavation Equipment, Generators & High Frequency Welding.



Ear Muff Foldable Deluxe

Ref. EP 22

NRR 26 dB

SNR 30 dB

- ▶ Soft padded plastic Head Bands Folds for dust free storage in pocket or a bag.
- ▶ Soft cushioned pads for good seal against noise.
- ▶ Conforming to EN 352-1:1993
- ▶ Recommended Areas: Industrial, Agricultural & Construction Machinery.



Ear Muff Helmet Attachable

Ref. EP 23

NRR 27 dB

SNR 27 dB

- ▶ Designed specially to use with Helmets.
- ▶ Spring loaded Stand- off function to press firmly to the ear for better seal against noise.
- ▶ Easy Snap-On/Off Mechanism for Helmet Mounting
- ▶ Soft cushioned pads for good seal against noise.
- ▶ Conforming to EN 352-1:1993.
- ▶ Recommended Areas: Industrial, Agricultural & Construction Machinery.





CE



Call **KARAM** Safety Expert
for further advise
Toll Free No.: 1800 103 7085

Ear Muff High Db Foldable

Ref. EP 24

NRR 29 dB

SNR 33 Db

- ▶ Designed to provide High Db attenuation with extra thick protective Ear Cups.
- ▶ Plastic Head Band Folds for dust free storage in pocket or a bag.
- ▶ Provided with soft foam pads for extra comfort.
- ▶ Soft cushioned pads for good seal against noise.
- ▶ Conforming to 352-1:1993
- ▶ Recommended Use: Medium to Heavy Industrial Applications





Catch basin prevents Ear Plugs from falling to ground

Dispenser for Ear Plug 01
Ref. EP 300

- ▶ Light weight Plastic Dispenser
- ▶ Used as a table top unit.
- ▶ Allows easy access to the user.
- ▶ Can contain 300 pairs at a time and be easily refilled.
- ▶ Dispense ear plug by a simple ear plug from falling to ground.



EP 03 (CC)

Packing for Disposable Foam Ear Plugs
EP 01/02

- ▶ 1 pair/ zipper polybag x 200 pairs.
- ▶ 10,000 pairs/ carton or duplex paper.
- ▶ Also available in Dispenser carton of 200 pairs.

Packing for Reusable Ear Plugs
EP 03/04

- ▶ 1 pair/ zipper polybag x 200 pairs.
- ▶ 10,000 pairs/ carton or duplex paper.
- ▶ Also available in convenient carrying case EP 03 (CC)/ EP 04 (CC).

It is important to use suitable hearing protectors to safeguard against overexposure to Noise.

Permissible Noise Exposures as per OSHA 29 CFR 1910.95

Sound level (Decibel: dB)	Duration in hours
90	8
92	6
95	4
97	3
100	2
102	1 ½
105	1
110	½
115	¼ or less

The Table below gives the average decibel levels in some of the common industrial and work areas :-

Noise Source	Average Decibel Level: dB
Jet take-off (at distance of 25 meters)	150
Aircraft carrier deck	140
Thunderclap, chain saw. Oxygen torch (121 dB).	120
Steel mill, auto horn at 1 meter. Turbo-fan aircraft at takeoff power at 200 ft (118 dB). Riveting machine (110 dB)	110
Power mower (96 dB); Newspaper press (97 dB).	90
Average factory, milling machine (85 dB)	80
Conversation in restaurant, office, background music	60
Conversation at home.	50
Whisper, rustling leaves	20



Foot Protection

Know your **KARAM**® Safety Shoe



THERMOPLASTIC STIFFENER

For excellent shape to the heel



LACES
Strong Laces for better grip

TONGUE
Cushioned with PU Foam
for extra comfort

VAMP
Made of Grain
Leather

UPPER

EYELETS
With high corrosion resistance

MID SOLE
For extra Shock Absorption

ROBUST OUT SOLE
For maximum durability

REINFORCED TOE
for maximum Safety
(tested to withstand more than 200J)

The portfolio of KARAM Safety Footwear encompasses a wide range of products that are manufactured and certified to the highest standards of **EN, IS and DGMS**.

The manufacturing process in KARAM Footwear Production involves highly controlled **Injection moulding, robotic processes, automatic stitching lines, conveyerized assembly lines**, etc. The outcome is a product that has passed through strict quality parameters all across its manufacturing process till its final stage of packaging.

A dedicated **Designing Team** and a highly equipped **Laboratory** enables KARAM to evolve and innovate to fulfill the safety requirements of its esteemed customers, to suite their needs in toughest of the work conditions.

CROSS-SECTION VIEW



Unique Features of KARAM Safety Footwear for Complete Foot Protection

Made of GRAIN LEATHER

KARAM Safety shoes are made up of 100% grain leather, ensuring highest level of ergonomics and comfort to the users.



KARAM Safety Shoe OUT-SOLE

KARAM Offers a wide range of single density (PU) and Double density (PU/TPU and PU/PU) Foot wear out soles which are injection moulded onto the shoe.

Polyurethane

The Double Density PU Outsoles in some models of KARAM Safety Shoes provide superb Shock Absorption and durability, yet light in weight, and flexible.

Thermo-polyurethane

The premium models of KARAM Safety Footwear are made of Double Density Out soles. The TPU Out-sole offers excellent abrasion resistance, slip resistance, extra comfort and flexibility.

Unique DUAL DENSITY POLYURETHANE Outsole of KARAM Shoes



Inner Layer being softer imparts Shock Absorbing properties hence provides increased comfort.

Outer Layer is denser and harder, hence provides maximum Abrasion resistance thereby greatly increasing the life of the Sole.

TOE PROTECTION in KARAM Safety Footwear

KARAM Safety Footwear are provided with Toe-caps that are tested and certified as per **EN 12568:2010**

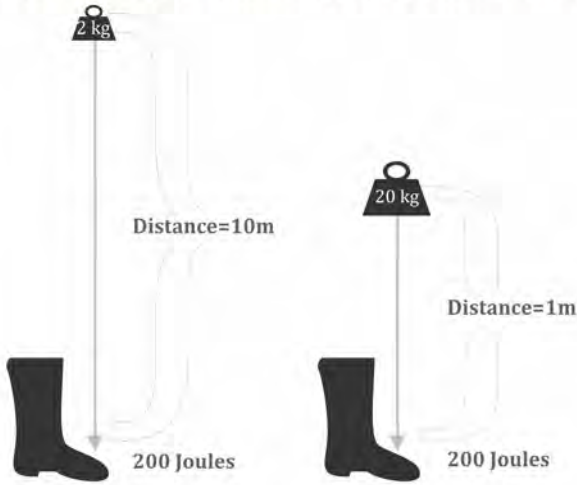

They are tested to **withstand an impact load of 200J**, and a Compression load of 15 kN.

The Toe caps have a **wide design** so as to suit feet of broad sizes as well, hence provide maximum comfort at all levels.

KARAM offers different models of Shoes incorporated with **STEEL TOE** or with **COMPOSITE TOE**

KARAM Steel-Toe

The Steel Toe caps used in KARAM Shoes are manufactured from Carbon Steel.

Have a surface finish to make them highly corrosion resistant.

Tested and certified as per **EN12568:2010**



KARAM Composite-Toe

KARAM Shoe models come incorporated with the special Composite toe, which is made of high strength Polymer.

Extremely light in weight.

Tested and certified as per **EN12568:2010**



KARAM Shoes come with ANTI-BACTERIAL PROPERTY

Bacteria present in our feet cause odour and harmful skin infection.

KARAM applies "Anti-Bacterial Screening" and "Anti-Bacterial Spray" on all Finished Goods before packing, to prevent bacterial and fungal growth in the Safety Shoes.



MID-SOLE PROTECTION in KARAM Safety Footwear

To fight the hazards of injury to the foot due to piercing of sharp objects- for **S1 P** level of protection.

The **KARAM Steel Mid-Plate** is constructed of Carbon Steel, having high strength, and is tested for Penetration Test of 1100 N, as per **EN 12568:2010**.

It is also highly corrosion resistant.

KARAM Steel Mid-Plate ensures that a worker can work uninhibited on hazardous sites without worrying about any sharp objects, which may pierce through the shoe from under, and harm his foot.

All models of KARAM Safety Footwear can be equipped with a Steel Mid-Plate, to enhance the protection level of the Safety Shoe to S1 P category.



Introducing for the first time in India by KARAM, the unique "NAIL-GUARD" In-Sole:



Features of the New NAIL-GUARD In-Sole- by KARAM

- ▶ Light weight
- ▶ Non-Mettallic
- ▶ Extreme level of flexibility - allowing the foot to flex up to 90 degrees
- ▶ High Anti-Peneration Property
- ▶ Tested for Penetration Test of 1100 N, conforms to EN 12568:2010.

All KARAM Safety Shoe models can be provided with the "NAIL-GUARD" In-sole for S1 P protection, on request.

MARK OF QUALITY & TRACEABILITY of KARAM Footwear

All KARAM Shoes are also provided with a unique **Batch number** for each batch being manufactured, ensuring **100% traceability**.



Call **KARAM** Safety Expert for further advise
Toll Free No.: 1800 103 7085

KARAM Safety Footwear—equipped with ANTI-STATIC PROPERTY

Charges build up in the body while we work through the day, as a result of various non-conductive materials that rub against us and each other.

If we wish to avoid static charges, we must ensure that the charges should not be allowed to build up in the body, and should be continuously dissipated into the ground (commonly termed as “earthing”).

KARAM Anti-static shoe provides an easy access of this charge to flow from the body into the Earth.

The sole of this shoe is made in such a way that an easy channel is provided to dissipate these static charges to the ground.

KARAM Safety Shoe is tested for Anti-Static property for its Electrical Resistance to between 100 kilo ohms and 1000 mega ohms, as per EN 20345:2011.

What is ESD (Electro Static Discharge property)?

A Safety Shoe is termed to have an ESD property when it is able to dissipate even smaller pockets of charges, and electrical resistance from 100 kilo ohms to 35 mega ohms. **The Shoe is tested for its ESD Property as per EN 20345:2011**

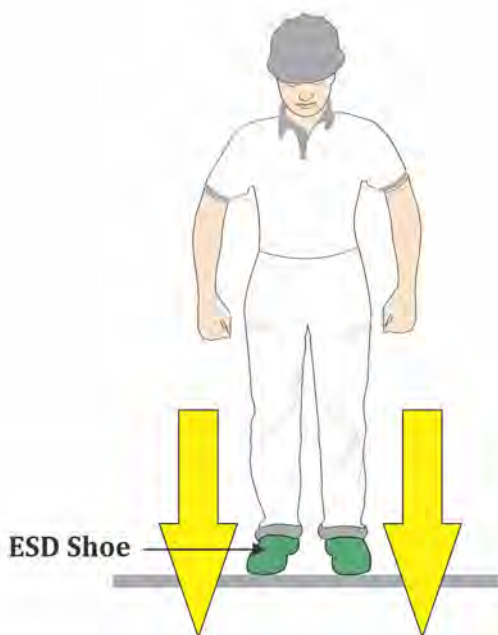
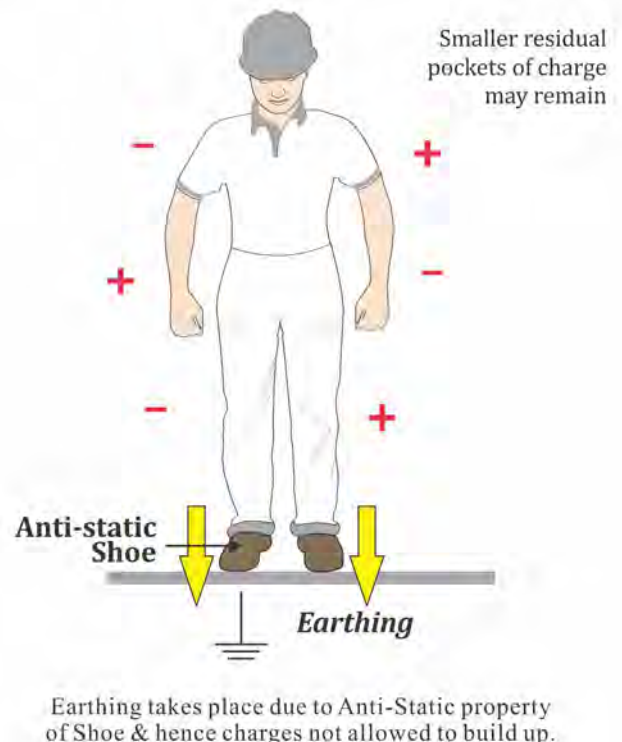
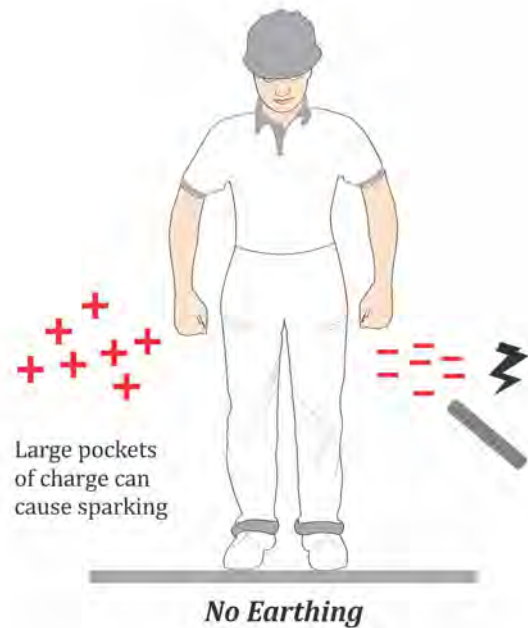

Rapid dissipation of charge due to improved conductivity takes place. Virtually No residual pockets of charge remain when using a Shoe having ESD property.

SLIP-RESISTANT TREAD PATTERN of KARAM Shoes

The Tread-Pattern of all KARAM Footwear has been technically designed to ensure a perfect grip and safety in all working environment.

The Cleated Tread-Pattern in both the Sole-Designs of KARAM Shoes offers highest level of grip and Slip-Protection, providing compliance with Slip-Resistance Norm at protection level of SRC.



Cleated Sole for firm grip on uneven ground and slippery surfaces.

Treads for protection while climbing ladder.

WHAT IS SRC SLIP RESISTANCE?

It is a high level of slip resistance, and is depicted as a combination of slip resistance A and slip resistance B, as per EN ISO 20345:2011

$$\text{Therefore, SRC} = \text{SRA} + \text{SRB}$$

Slip Resistance SRA

Slip resistance of shoe is checked on **Ceramic tile** over which **detergent solution** is poured. KARAM shoe achieves this slip resistance requirement.

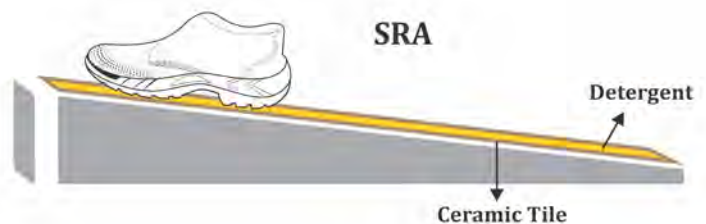

Slip Resistance SRB

Slip resistance of shoe is checked on **Steel surface** over which **glycerin** is poured. KARAM shoe achieves this slip resistance requirement.

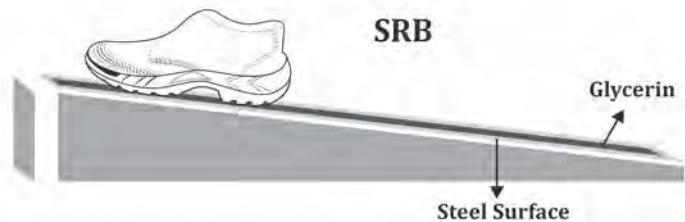

Since KARAM Shoe achieves both SRA and SRB, it has hence a compliance to Slip Resistance at protection level of SRC

KARAM Shoes- to SUIT ALL SIZES

KARAM Shoes are provided with a vast range of sizes, for Men from size 3 to size 12, and for Women from size 3 to size 8. Choosing the correct size of the shoe ensures complete safety, comfort and durability of the shoe.

Available in Size:
Mens Shoes : 3-12
Ladies Shoes : 3-8

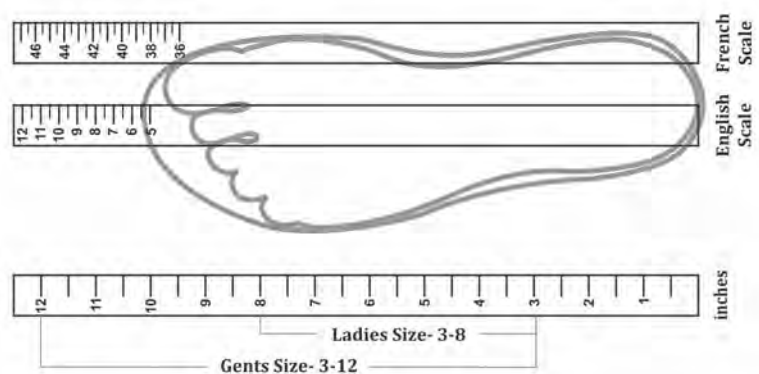

SAFETY FOOTWEAR



HOW TO USE FOOTWEAR OPTIMALLY

Make sure that the footwear matches the hazard category required, according to type and workplace. For this purpose, reference is made to the relevant European standards and any additional specifications.

EUROPEAN NORMS (EN)

EN ISO 20345: 2011

The safety footwear that is expected to comply with the norm is marked with the letter "S" (Safety) followed by the letter "B" (Basic) or numbers showing the category it belongs to.

Category SB (Basic Safety) involves the following requirements:

Steel Toe, 200 Joules

SB- Basic Characteristics

S1- Has SB characteristics supplemented with the following:

- ▶ Antistatic footwear (A)
- ▶ Energy absorption in the heel region (E)
- ▶ Closed heel area

S2- Has S1 characteristics supplemented with the following:

- ▶ Water proof upper (WRU), no penetration of water for at least 1 hour

S3- Has S2 characteristics supplemented with the following:

- ▶ Anti penetration midsole (P)
- ▶ Slip resistance sole

Additional Requirements and safety standards	EN 345	SB	S1	S2	S3
Antistatic footwear	-	-			
Energy absorption in the heel region	-	-			
Resistance to hydrocarbons	-	-			
Water resistant upper (for at least 1h)	-	-	-		
Penetration resistance (Steel midsole)	-	-	-	-	
Cold insulation	-	-	-	-	-
Heat resistance of outer sole (at 150 °C for 1 min.)	-	-	-	-	-
Conductive footwear	-	-	-	-	-

KARAM Safety Footwear - GRIPP Series Conforms to ISI & CE Standards & provide SB, S1, S1P, S2, S3 Category of Foot Safety.

EN ISO 20345:2011, EN ISO 20345/ A1:2011, IS 15298 (Part 2) : 2011

KARAM Safety Footwear Comply to the Classes : SB, S1, S1P, SRC

SYMBOLS USED IN SHOE SAFETY



100%
Grain Leather



Slip-Resistant
Tread Pattern



Antistatic Shoe



Summer Shoe



Anti-bacterial
Property



Oil & Fuel
Resistant Sole



Toe Protection



Mid-Sole
Protection



Shock Absorbant
Heel



Ankle Protection



Anti-Fatigue



ESD



Heat Resistance



Warm Insulation



Cold Insulation



Water-Resistant
Shoe

Test for Insulation against Heat

The foot is protected from extreme heat as in Metal industries, or Road laying etc. by a footwear designed to insulate the foot from heat.

According to Indian and European Standards, when the shoe is kept at 150°C for 1 minute, Internal temperature of the Shoe should not rise to more than 22°C. KARAM shoes are tested to conform to this.

Permeability Test



Property of material to permit odour to pass through it is checked in this test.

KARAM SAFETY FOOTWEAR
SUBJECTED TO A SERIES OF QUALITY TESTS
IN THE WELL EQUIPPED KARAM FOOTWEAR-TESTING LABORATORY....
TO ENSURE THAT ONLY THE BEST REACHES THE VALUED CUSTOMER!

Abrasion Resistance Test



This Test is carried out to assess the capability of the Outsole to resist against abrasion.

Lining Abrasion Test

This test is performed to measure the abrasion of lining materials, Upper Fabrics, Sock lining and synthetic coated fabrics.

Electrical Resistance Test

This test is performed to determine the electrical resistance of Shoe.

Compression Resistance Test



The Steel Toe Cap also protects the foot from compression loads. According to Indian and European Standards, the Clearance below Toe Cap after applying 15 kN compression load, should not be less than specified value.





Steel Toe Impact Test



The Shoe is provided with a Steel Toe Cap to protect the foot from falling objects. This test is carried out to ensure that there is enough Safety Clearance (as per a specified value in the Norms) below the Toe Cap after an impact of 200 Joules.

Robotic Operations



KARAM shoe manufacturing processes also involve Robotic Machinery that enables high level of accuracy to maintain quality and production.

Penetration Resistance Test for Mid-sole



The Shoe is provided with a Steel Mid Sole to protect the foot from any sharp objects penetrating Shoe Sole. According to Indian and European Standard, Nail should not penetrate at 1100 N.

Automated Injection Moulding of the sole



KARAM Safety Shoe passes through an automated lasting line, and Automated Injection Moulding Plant (Desma Machine) and through a series of operations on a well defined conveyer... Finally emerging as the finest quality Footwear for Safety in the Industry.

Sole Flexing Test



KARAM also performs a series of Sole Flex Testing, subjecting the Sole to a constant cycle of 30,000 flexes. This Test ensures that the Sole of the shoe does not break while being subjected to normal foot flexing and movement.

PREMIUM SHOE RANGE

KARAM Premium Range of Safety Shoes come with the highest level of Ergonomics, combined with Robust Looks & Highest Level of Foot Protection.

This range of Safety Shoes come with the following unique features:

- A) **Molded In-sock for highest level of comfort:** The premium range of KARAM Safety Shoes are provided with molded In-sock heel cup which work to support and protect the feet. The special molded heel helps in providing comfort and prevents fatigue during long hours of working.
- B) **Breathable Drylex lining in KARAM premium shoe range:** This is a special Drylex breathable lining, 3-D fabric. It prevents moisture and perspiration, providing high sweat absorption property for a dry feel, and hence adds to the comfort of the wearer.
- C) **Out sole double density PU/TPU:** This range of KARAM safety shoes comes with double density PU/TPU for extreme comfort and high abrasion resistance.
- D) **Wider cushioned Top line:** For extended comfort.
- E) **Anti-Fatigue:** Anti-Fatigue insoles relieve discomfort from prolonged standing, stressed feet, legs and back.



Ref. FS 61



Description

Executive Safety Shoe equipped with all the features of comfort, robust looks and highest level of safety.

Distinguished Features

- ▶ Metallic hexagonal eyelets.
- ▶ Round Brown laces.
- ▶ Tan Leather upper and Beige lining.

General Features

- Upper** : Made from Buff Crazy Horse Brown leather.
- Quarter Lining** : Has a special Breathable Drylex lining,3D fabric. It prevents moisture and perspiration, providing high sweat absorption property for a dry feel. It is also highly resistant to abrasion.
- Vamp Lining** : Comfortable, Breathable soft fleece lining provides soft feel to the toe area.
- Insock** : Extra cushioned soft moulded In-sock for better arch support and an extended comfort.

Sole Features

- ▶ Double density PU/PU sole for high durability and flexibility.
- ▶ Cleated Outsole with wider cleats for higher grip and self cleaning effect.
- ▶ Antistatic, Oil/Acid Resistant, Anti Slip and Heat Resistant with shock absorbing property, Anti Fatigue.

Standard

Conforming to EN 20345:2011 & IS 15298:2011 & DGMS

Protection Level - S1

Category - Design A

Sizes

3 to 12



Ref. FS 61





Ref. FS 62



Description

Safety Shoe equipped with all the features of comfort, robust looks and highest level of safety.

Distinguished Features

- ▶ Reflective Tapes on Shoe for high visibility in the dark.
- ▶ Equipped with Eyelet Hooks & flat laces for better knotting grip.
- ▶ Codura fabric enhances breathability, makes shoe lighter in weight. Is more durable and Flexible.
- ▶ Foam padding in bellow tongue to enhance fit & comfort.

General Features

- Upper** : Made from Buff Black Crazy Horse leather and Codura grey.
- Quarter Lining** : Breathable Grey Drylex lining, 3D fabric. It prevents moisture and perspiration, providing high sweat absorption property for a dry feel. It is also highly resistant to abrasion.
- Vamp Lining** : Comfortable, Breathable soft fleece lining provides soft feel to the toe area.
- Insock** : Extra cushioned soft moulded In-sock for extended comfort.

Sole Features

- ▶ Double density PU/TPU sole for high durability and flexibility.
- ▶ Cleated Outsole with wider cleats for higher grip and self cleaning effect.
- ▶ Antistatic, Oil/Acid Resistant, Anti Slip and Heat Resistant with shock absorbing property, Anti Fatigue

Standard

Conforming to EN 20345:2011 & IS 15298: 2011

Protection Level - S1

Category - Design A

Sizes

3 to 12



Ref. FS 62



Ref. FS 63



Description

Safety Shoe equipped with all the features of comfort, robust looks and highest level of safety. Extended top line for wider foot coverage

Distinguished Features

- ▶ Equipped with Reflective Tapes on Shoe for high visibility in the dark.
- ▶ Codura fabric enhances breathability, makes shoe lighter in weight. Is more durable and Flexible.

General Features

- Upper** : Made from Buff Black Crazy Horse leather and Codura black.
- Quarter Lining** : Attractive Orange Spacer lining, 3D fabric. It prevents moisture and perspiration, providing high sweat absorption property for a dry feel. It is also highly resistant to abrasion
- Vamp Lining** : Comfortable, Breathable soft fleece lining provides soft feel to the toe area
- Insock** : Extra cushioned soft moulded In-sock for extended comfort.

Sole Features

- ▶ Double density PU/TPU sole for high durability and flexibility.
- ▶ Cleated Outsole with wider cleats for higher grip and self cleaning effect.
- ▶ Antistatic, Oil/Acid Resistant, Anti Slip and Heat Resistant with shock absorbing property, Anti Fatigue

Standard

Conforming to EN 20345:2011 & IS 15298: 2011

Protection Level - S1

Category - Design A

Sizes

3 to 12



Ref. FS 63



Ref. FS 64



Description

High executive end shoe with soft suede leather providing the finest features in safety & comfort.

Distinguished Features

- ▶ Equipped with Perforated quarters for extended air flow to reduce sweat & odour
- ▶ Light weight Metallic strong D-Ring eyelets.
- ▶ Has a Reflective Stripe on the counter and on the back ankle area for high visibility in the dark.

General Features

- Upper** : Made from Soft breathable Suede leather.
- Quarter Lining** : Attractive Grey Spacer lining, 3D fabric. It prevents moisture and perspiration, providing high sweat absorption property for a dry feel. It is also highly resistant to abrasion.
- Vamp Lining** : Comfortable, Breathable soft fleece lining provides soft feel to the toe area.
- Insock** : Extra cushioned soft moulded In-sock for extended comfort.

Sole Features

- ▶ Double density PU/TPU sole for high durability and flexibility.
- ▶ Cleated Outsole with wider cleats for higher grip and self cleaning effect.
- ▶ Antistatic, Oil/Acid Resistant, Anti Slip and Heat Resistant with shock absorbing property, Anti Fatigue

Standard

Conforming to EN 20345:2011 & IS 15298: 2011

Protection Level - S1

Category - Design A

Sizes

3 to 12



Ref. FS 64



Ref. FS 65



Description

Unique designed ankle protection shoe.

Distinguished Features

- ▶ Equipped with Textile Loop Eyelets with high visibility reflective tape.
- ▶ Non-Metallic Shoe- Ideal for Transmission Industry, Pharmaceutical & Electronic Industry.
- ▶ Composite Toe.
- ▶ Foam padding in bellow tongue to enhance fit & comfort.

General Features

- Upper** : Made from Buff crazy horse brown leather and Codura Brown
- Quarter Lining** : Orange Drylex lining, 3D fabric. It prevents moisture and perspiration, providing high sweat absorption property for a dry feel. It is also highly resistant to abrasion.
- Vamp Lining** : Normal vamp lining.
- Insock** : Extra cushioned soft moulded In-sock for extended comfort.

Sole Features

- ▶ Double density PU/TPU sole for high durability and flexibility.
- ▶ Cleated Outsole with wider cleats for higher grip and self cleaning effect.
- ▶ Oil/Acid Resistant, Anti Slip and Heat Resistant with shock absorbing property, Anti Fatigue.
- ▶ Electric Shock Resistance Sole.

Standard

Conforming to EN 20345:2011 & IS 15298: 2011

Protection Level - S1

Category - Design B

Sizes

3 to 12



Ref. FS 65





The New KARAM GRIP Series of Safety Shoes come with a revolutionary sole design for Excellent Grip, Comfort and Slip Resistance.

Ref. FS 01



Description

Smart Deluxe Executive Shoe for complete foot safety.

Distinguished Features

- ▶ Has smart red stitching with bonded thread.

General Features

- Upper** : Made from Full Grain leather.
- Quarter Lining** : Netlon padded with foam.
- Vamp Lining** : Highly abrasion resistant fabric lining.

Sole Features

- ▶ Double density PU/PU sole for high durability and flexibility.
- ▶ Cleated Outsole with wider cleats for higher grip and self cleaning effect.
- ▶ Antistatic, Oil/Acid Resistant, Anti Slip and Heat Resistant with shock absorbing property, Anti Fatigue

Standard

Conforming to EN 20345:2011 & IS 15298: 2011 & DGMS

Protection Level - S1

Category - Design A

Sizes

3 to 12



Ref. FS 01



Call **KARAM** Safety Expert
for further advise
Toll Free No.: 1800 103 7085

Ref. FS 02



Description

Deluxe Workman's Choice Safety Shoe providing safety with comfort.

Distinguished Features

- ▶ Has smart grey stitching with bonded thread.

General Features

- Upper** : Made from Full Grain leather.
- Quarter Lining** : Grey Cambrel lining.
- Vamp Lining** : Highly abrasion resistant fabric lining.

Sole Features

- ▶ Single density PU sole.
- ▶ Cleated Outsole with wider cleats for higher grip and self cleaning effect.
- ▶ Antistatic, Oil/Acid Resistant, Anti Slip and Heat Resistant with shock absorbing property, Anti Fatigue

Standard

Conforming to EN 20345:2011 & IS 15298: 2011 & DGMS

Protection Level - S1

Category - Design A

Sizes

3 to 12

* Available in two tread options -
Gripp-Tread and Klasp-Tread designs



Call **KARAM** Safety Expert
for further advise
Toll Free No.: 1800 103 7085



Ref. FS 02



Ref. FS 04



Description

New Executive choice Slip-on Shoe for the Smart Executive on the move.

Distinguished Features

- ▶ Easy slip-on design and cushioned top-line.

General Features

- Upper** : Made from Full Grain leather.
- Quarter Lining** : Netlon padded with foam.
- Vamp Lining** : Highly abrasion resistant fabric lining.

Sole Features

- ▶ Single density PU sole.
- ▶ Cleated Outsole with wider cleats for higher grip and self cleaning effect.
- ▶ Antistatic, Oil/Acid Resistant, Anti Slip and Heat Resistant with shock absorbing property, Anti Fatigue

Standard

Conforming to EN 20345:2011 & IS 15298: 2011 & DGMS

Protection Level - S1

Category - Design A

Sizes

3 to 12

* Available in two tread options -
Gripp-Tread and Klasp-Tread designs



Ref. FS 04





Ref. FS 05



Description

Worker's Safety Shoe providing safety with comfort.

General Features

- Upper** : Made from Full Grain leather.
Quarter Lining : Black Cambrel lining.
Vamp Lining : Highly abrasion resistant fabric lining.

Sole Features

- ▶ Single density PU sole.
- ▶ Cleated Outsole with wider cleats for higher grip and self cleaning effect.
- ▶ Antistatic, Oil/Acid Resistant, Anti Slip and Heat Resistant with shock absorbing property, Anti Fatigue

Standard

Conforming to EN 20345:2011 & IS 15298: 2011 & DGMS

Protection Level - S1

Category - Design A

Sizes

3 to 12



Ref. FS 05



Call **KARAM** Safety Expert
for further advise
Toll Free No.: 1800 103 7085

Ref. FS 21



Description

This model is a smart lace up shoe providing a complete protection to the ankle.

Distinguished Features

- ▶ Ankle protection Shoe.
- ▶ Has bellow tongue which prevents spillage of water and liquids inside the shoe.
- ▶ Metallic D-Ring eyelets and flat laces for better knotting grip.
- ▶ Has attractive red stitching with bonded thread.

General Features

- Upper** : Made from Full Grain leather.
Quarter Lining : Netlon padded with foam.
Vamp Lining : Highly abrasion resistant fabric lining.

Sole Features

- ▶ Double density PU/PU sole for high durability and flexibility.
- ▶ Cleated Outsole with wider cleats for higher grip and self cleaning effect.
- ▶ Antistatic, Oil/Acid Resistant, Anti Slip and Heat Resistant with shock absorbing property, Anti Fatigue

Standard

Conforming to EN 20345:2011 & IS 15298: 2011 & DGMS

Protection Level - S1

Category - Design B

Sizes

3 to 12



Ref. FS 21



Ref. FS 22



Description

An ankle height Quick-Release Boot. Extremely easy to remove in case of injury to the foot.

Distinguished Features

- ▶ Equipped with unique special Keeper for releasing the boot in case of injury to the shoe.

General Features

- Upper** : Made from Full Grain Leather Topline with Codura.
- Quarter Lining** : Has a special Breathable Drylex lining, 3D fabric. It prevents moisture and perspiration, providing high sweat absorption property for a dry feel. It is also highly resistant to abrasion.
- Vamp Lining** : Highly abrasion resistant fabric lining.

Sole Features

- ▶ Double density PU/PU sole for high durability and flexibility.
- ▶ Cleated Outsole with wider cleats for higher grip and self cleaning effect.
- ▶ Antistatic, Oil/Acid Resistant, Anti Slip and Heat Resistant with shock absorbing property, Anti Fatigue

Standard

Conforming to EN 20345:2011 & IS 15298: 2011 & DGMS

Protection Level - S1

Category - Design B

Sizes

3 to 12



Easy to pull out special keeper to release the boot without untying the laces.



Ref. FS 22



Ref. FS 51



Description

High ankle boot integrated with Fire Retardant threads specific for hot work.

Distinguished Features

- ▶ High ankle design and fire retardant thread provides safety to the foot while working on hot surfaces.

General Features

- Upper** : Made from Full Grain Buff waxy leather.
- Quarter Lining** : Unlined shoe for rough usage.
- Vamp Lining** : Highly abrasion resistant fabric lining.

Sole Features

- ▶ Double density PU/PU sole for high durability and flexibility.
- ▶ Cleated Outsole with wider cleats for higher grip and self cleaning effect.
- ▶ Antistatic, Oil/Acid Resistant, Anti Slip and Heat Resistant with shock absorbing property, Anti Fatigue

Standard

Conforming to EN 20345:2011 & IS 15298: 2011 & DGMS

Protection Level - S2

Category - Design C

Sizes

3 to 12



Ref. FS 51



**EXECUTIVE
SAFETY SHOES**

KARAM introduces Executive Safety Shoes made in Moccasin design, having exclusive features, providing maximum foot safety to the wearer.

This range of Safety Shoes comes with the following unique features:

- ▶ This range of shoes comes with KARAM light weight Nail-Guard Anti-perforation Mid-sole, to provide maximum safety, along with great flexibility to the foot.
- ▶ The Outsole is Single Density PU, imparts high level of abrasion resistance.
- ▶ Comfortable molded In-sock provides comfort during long hours of working.
- ▶ The Out sole has Antistatic, Antislip, Oil & Heat Resistant properties.
- ▶ Comfortable fabric lining of the Shoes also makes it sweat and odour free.
- ▶ Conforming to EN 20345:2011 & IS 15298: 2011
- ▶ Category: S1 P (Safety Category)

Ref. FS 71



Description

Smart lace up high end Executive shoe.

Distinguished Features

- ▶ High end light weight shoe
- ▶ Moccasin design having broad area for extended comfort
- ▶ Inbuilt antiperforation Nail Guard insole
- ▶ Molded In-Sock for anti fatigue property
- ▶ Waxy Buff leather with options of 2 colours-Black & Chocolate Brown
- ▶ Composite Toe Cap

General Features

- Upper** : Made from Buff waxy leather.
- Quarter Lining** : Black/Grey Z fabric padded with soft foam for exceptional grip & comfort. Antiperspirant.
- Vamp Lining** : Special fabric with foam support.
- Insock** : Soft moulded In-sock for antifatigue.

Sole Features

- ▶ Single density PU sole.
- ▶ Cleated Outsole with wider cleats for higher grip and self cleaning effect.
- ▶ Antistatic, Oil/Acid Resistant, Anti Slip and Heat Resistant with shock absorbing property, Anti Fatigue

Standard

Conforming to EN 20345:2011 & IS 15298: 2011

Protection Level - S1 P

Category - Design A

Sizes

3 to 12

S1 P

New



Ref. FS 71



Call **KARAM** Safety Expert
for further advise
Toll Free No.: 1800 103 7085

Ref. FS 72



Description

Attractive design Slip on shoe.

Distinguished Features

- ▶ High end light weight Zero metal shoe
- ▶ Moccasin design having broad area for extended comfort
- ▶ Inbuilt antiperforation Nail Guard insole
- ▶ Molded In-Sock for anti fatigue property
- ▶ Waxy Buff leather with options of 2 colours-Black & Chocolate Brown
- ▶ Composite Toe Cap

General Features

- Upper** : Made from Buff waxy leather.
- Quarter Lining** : Black/Grey Z fabric padded with soft foam for exceptional grip & comfort. Antiperspirant.
- Vamp Lining** : Special fabric with foam support.
- Insock** : Soft moulded In-sock for antifatigue.

Sole Features

- ▶ Single density PU sole.
- ▶ Cleated Outsole with wider clits for higher grip and self cleaning effect.
- ▶ Antistatic, Oil/Acid Resistant, Anti Slip and Heat Resistant with shock absorbing property, Anti Fatigue

Standard

Conforming to EN 20345:2011 & IS 15298: 2011

Protection Level - S1 P

Category - Design A

Sizes

3 to12



Ref. FS 72



Ref. FS 73



Description

Zero metal Slip on shoe with padded top line for comfort.

Distinguished Features

- ▶ High end light weight Zero metal shoe
- ▶ Slip on with padded top line for comfort
- ▶ Design with Broad Toe area for extended comfort
- ▶ Inbuilt anti perforation Nail Guard insole
- ▶ Molded In-Sock for anti fatigue property
- ▶ Waxy Buff leather with options of 2 colours-Black & Chocolate Brown
- ▶ Composite Toe Cap

General Features

- Upper** : Made from Buff waxy leather.
- Quarter Lining** : Most durable breathable soft leather lining.
- Vamp Lining** : Comfortable, Breathable soft fleece lining provides soft feel to the toe area.
- Insock** : Soft moulded In-sock for antifatigue.

Sole Features

- ▶ Single density PU sole.
- ▶ Cleated Outsole with wider cleats for higher grip and self cleaning effect.
- ▶ Antistatic, Oil/Acid Resistant, Anti Slip and Heat Resistant with shock absorbing property, Anti Fatigue

Standard

Conforming to EN 20345:2011 & IS 15298: 2011

Protection Level - S1 P

Category - Design A

Sizes

3 to12



Ref. FS 73





LADIES SHOE RANGE

Stylish & Safe. KARAM Ladies Shoes are specially designed with soft female feet in mind. The Shoe Sole are narrower, looks elegant and are soft and comfortable than common male safety shoes.

Ref. FS 100



Description

Lace up Shoe for the woman on the Go!

Distinguished Features

- ▶ Light weight shoe
- ▶ Lace up shoe, Smart, Slim design
- ▶ Inbuilt antiperforation Nail Guard insole
- ▶ Padded tongue for enhanced comfort
- ▶ Padded top line for comfort
- ▶ Composite Toe Cap

General Features

- Upper** : Made from Buff waxy black Codura leather.
- Quarter Lining** : Soft pink breathable spacer lining, 3D fabric. It prevents moisture and perspiration, providing high sweat absorption property for a dry feel. It is also highly resistant to abrasion.
- Vamp Lining** : Comfortable, Breathable soft fleece lining provides soft feel to the toe area.
- Insock** : Pink Soft moulded In-sock for antifatigue.

Sole Features

- ▶ Single density PU sole.
- ▶ Cleated Outsole with wider cleats for higher grip and self cleaning effect.
- ▶ Antistatic, Oil/Acid Resistant, Anti Slip and Heat Resistant with shock absorbing property, Anti Fatigue

Standard

Conforming to EN 20345:2011 & IS 15298: 2011

Protection Level - S1P

Sizes

3 to 8

S1P

New



Ref. FS 100



Ref. FS 101



Description

Easy wear ladies Safety Shoe with velcro fitment for women.

Distinguished Features

- ▶ Equipped with Velcro fitment.

General Features

- Upper** : Made from grain leather.
- Quarter Lining** : Netlon padded with foam.
- Vamp Lining** : Highly abrasion resistant fabric lining.

Sole Features

- ▶ Single density PU sole.
- ▶ Cleated Outsole with wider cleats for higher grip and self cleaning effect.
- ▶ Antistatic, Oil/Acid Resistant, Anti Slip and Heat Resistant with shock absorbing property, Anti Fatigue

Standard

Conforming to EN 20345:2011 & IS 15298: 2011

Protection Level - S1

Sizes

3 to 8



Ref. FS 101



OCCUPATIONAL SHOES

KARAM Introduces high cut occupational shoes specifically designed for tough situation of Para Military Forces.



All the shoes in this section are available in two distinct tread options

Gripp and Klasp



GRIPP™ Design of Sole
SERIES

KLASP™ Design of Sole

Ref. FS 150



Description

Oxford dress shoes specially designed for Institutional use.

General Features

- Upper** : Made from waxy leather.
- Quarter Lining** : Leather lining with all features.
- Vamp Lining** : Highly abrasion resistant fabric lining.
- Insock** : Soft odour free durable leather insock.

Sole Features

- ▶ Single density PU sole.
- ▶ Cleated Outsole with wider cleats for higher grip and self cleaning effect.
- ▶ Antistatic, Oil/Acid Resistant, Anti Slip and Heat Resistant with shock absorbing property, Anti Fatigue

Standard

Conforming to IS 15298: 2011

Sizes

3 to 12

** Available in two tread options- Gripp-Tread and Klasp-Tread designs*



Ref. FS 150



Call **KARAM** Safety Expert for further advise
Toll Free No.: 1800 103 7085



Ref. FS 151



Description

Jungle Boot specially designed for Paramilitary forces.

Distinguished Features

- ▶ Has special Corrosion Resistant Aluminium eyelets

General Features

- Upper** : Water Repellent polyester viscous fabric with grain leather hard toe.
- Quarter Lining** : Combrelle lining with foam padding.
- Insock** : Moulded Cambrelle Insock.

Sole Features

- ▶ Single density PU sole.
- ▶ Cleated Outsole with wider cleats for higher grip and self cleaning effect.
- ▶ Antistatic, Oil/Acid Resistant, Anti Slip and Heat Resistant with shock absorbing property, Anti Fatigue

Standard

Conforming to IS 15298: 2011

Sizes

3 to 12

** Available in two tread options-
Gripp-Tread and Klasp-Tread designs*



Ref. FS 151



Ref. FS 152



Description

Ankle boot specially designed for Paramilitary forces. Jug-Loop design for easy hanging.

General Features

- Upper** : Made from grain leather.
- Quarter Lining** : Simple Combrelle lining.
- Vamp Lining** : Highly abrasion resistant fabric lining.

Sole Features

- ▶ Single density PU sole.
- ▶ Cleated Outsole with wider cleats for higher grip and self cleaning effect.
- ▶ Antistatic, Oil/Acid Resistant, Anti Slip and Heat Resistant with shock absorbing property, Anti Fatigue

Standard

Conforming to IS 15298: 2011

Sizes

3 to 12

** Available in two tread options-
Gripp-Tread and Klasp-Tread designs*



Ref. FS 152



Call **KARAM** Safety Expert
for further advise
Toll Free No.: 1800 103 7085





KARAM has worked hard to understand what makes people use a Respirator. Comfort is critical. So we have gone far beyond a basic requirement and made our Respirators as comfortable as possible so that the users not only wear them, but want to wear them.

KARAM offers you a wide range of reusable and supplied Air Respirators for protection against gases, vapors, and particulates allowing you to choose the level and type of protection, comfort, style and maintenance requirements you need, to work safely, comfortable and effectively.

Respiratory Protection



TYPES OF RESPIRATORY PROTECTION EQUIPMENT FROM KARAM

Re-usable Half & Full Face Mask Respirators

For prolonged periods of use, Half and Full Face Mask, by KARAM offer exceptional value and quality, both in combination with comfort and ease of use.

- ▶ Offer protection against particulates, gases and vapors and combinations of the two.
- ▶ These Respirators have integrated or replaceable filters and parts. They may be cleaned, stored and reused provided they are in good condition.



HALF FACE MASK
CE



CE FULL FACE MASK

Supplied Air Respirator

Providing clean breathing air is essential when working in areas where hazardous contaminants are present. KARAM offers Supplied Air Respirator developed especially for toughest environments.

They offers comfortable protection against multiple hazards and their ease-of-use enables improved productivity in workplace.

- ▶ Offer protection against dusts, mists, fumes, vapours, and combination hazards.
- ▶ No increase in breathing resistance means more comfortable and longer wear time.
- ▶ Usable by a wide range of users regardless of facial characteristics , shape, size e.t.c



CE AIR LINE SYSTEM

KARAM Advantage: KARAM provides the unique Snap (Bayonet) Filter Attachment System with all Masks which allows the Filters to just be clicked into place ensuring optimum ease of use.

IDENTIFY THE COREECT RESPIRATORY PROTECTIVE EQUIPMENT

The choice of the right respiratory protective equipment and filter type depends on the particular working environment and individual requirements. Follow these three simple steps to choose the protection that helps you to achieve optimum results.

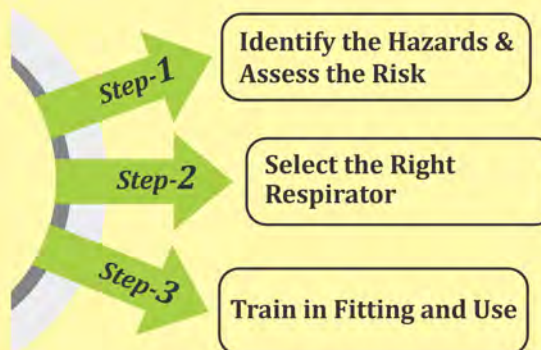

KARAM introduces a versatile range of Respiratory Protection Equipment (Half masks, Full Masks and Airline Systems) that provide extremely high level of protection to the user. These products are easy to wear and maintain, re-usable, and allow the use of replaceable Filters/Cartridges.

KARAM DUPLEX Half Face Mask Ref: RS 1101



This Reusable Half Face Mask offers versatility for many environments and applications. Provides protection against particulates and a wide variety of gases and vapors when used with approved cartridges and filters.

Area of use: Paint and Pesticide Spraying, Handling of Chemical toxic gases, Solvents and Dusts. Suitable for use in Chemical and Pharmaceutical companies, Agriculture, Mining Industry and in Ore Milling.

GENERAL FEATURES:

- ▶ Lightweight and easy to carry
- ▶ Dual-mode head harness for standard or drop-down mode
- ▶ Consists of Soft sealing flap, for providing comfort to the face
- ▶ Made of an extremely soft non-allergenic Thermoplastic Elastomer for comfort and fit
- ▶ Multiplex system equalizes facial pressure
- ▶ Exhalation Valve helps make breathing easier giving a cool & dry comfort to the user
- ▶ To be used with Snap in Cartridges/Filter made of shock & solvent resistant plastic
- ▶ Conforms to EN 140:1998

Connection Type: Special Connection Snap-in (Bayonet) Cartridges

Facepiece Type: Reusable Half Facepiece

Harness Type: 4 Point

Primary Material: Thermoplastic Elastomer

KARAM DUET Half Face Mask Ref: RS 1102



A reliable and convenient Respiratory Protection device suitable for many situations, helping provide protection against particulates and a wide variety of gases and vapors.

Area of Usage: Paint and Pesticide Spraying and in the handling of Chemical Products.

GENERAL FEATURES:

- ▶ Lightweight and easy to carry
- ▶ Dual-mode head harness for standard or drop-down mode
- ▶ Adjustable Elastic Bands
- ▶ Consists of Soft sealing flap, for providing comfort to the face
- ▶ Rigid shell which firmly holds the cartridges and evenly distributes the weight
- ▶ Multiplex system equalizes facial pressure
- ▶ Exhalation Valve helps make breathing easier giving a cool & dry comfort to the user
- ▶ Is used with Snap in Cartridges/Filter made of shock & solvent resistant plastic
- ▶ Sweat port in the lower interior part for intensive work in a hot & damp environment
- ▶ Conforms to EN 140: 1998

Connection Type: Special Connection Snap-in (Bayonet) Cartridges

Facepiece Type: Reusable Half Facepiece

Harness Type: 2 Point

Primary Material: Composite Plastic Material



Ref. Rs 1199(01)

PRE-FILTER prevents the particle filter element inside the Filter/ Cartridges, from clogging up too fast when used in particularly dusty environments.



Ref. RS 1199(02)

PRE FILTER HOLDER to hold Pre filter firmly in its place.



KARAM Full Face Mask

Ref: RS 1111



CE

Engineered for maximum protection, durability and visibility, this Respirator features panoramic, wide visibility and a large lens for superior peripheral vision.

Area of use: For Painting, Paint Manufacturing, Construction, Vehicle Manufacturing, Boat Building, Resin Manufacturing, Hospitals, Laboratories, Chemical Handling, Agriculture, Welding, Wood Working, Food Processing, Mining e.t.c

GENERAL FEATURES:

- ▶ Light weight & highly durable
- ▶ Provides high impact protection
- ▶ Comfortable & highly ergonomic in design
- ▶ One size fits all
- ▶ Easy to assemble and dismount
- ▶ Made of an extremely soft non-allergenic Thermoplastic rubber for comfort and fit
- ▶ Hard-coated polycarbonate scratch resistant lens
- ▶ Perfect undistorted vision
- ▶ Exhalation valve helps make breathing easier giving a cool & dry comfort to the user
- ▶ Quick Fastening Buckles which are easy to adjust and lock automatically
- ▶ Inner mask provided with two air circulation valves for preventing the visor from steaming up
- ▶ Nape Rest for wearing mask round the neck during breaks
- ▶ Conforms to EN 136: 98 (Class 2)

Connection Type: Snap-In (Bayonet)

Facepiece Type: Reusable Full Facepiece

Harness Type: 5 Point

Primary Material: Thermoplastic Elastomer for External Mask, Plain Polycarbonate lens for Visor, Head harness molded in Ethylene Propylene Diene Monomer (EPDM)

KARAM Full Face Mask can be used with the following Cartridges/ Filters



Ref. RS 1111(01)

Adapter and Special Connection (Snap) Cartridges/Filters: Adapter can be mounted onto the Full Face mask front connector with the help of the locking tabs provided on it. Cartridges can therefore be fitted on the Adapter with the help of with special quick connector.



Ref. RS 1111(02)

Full Face Mask Dual Adaptor only: Full Face Mask Adapter is designed to be used only with KARAM Full Face Mask Ref. RS 1111 in combination with KARAM Special Connection Cartridge /Filters series according to EN 14387 & EN143:2000

CE 0426



Call **KARAM** Safety Expert
for further advise
Toll Free No.: 1800 103 7085

KARAM Air Line System Ref: RS 1201



KARAM Air Line System is an isolating, continuous flow Airline Respirator provided with Full Face Mask. It is an efficient device to protect Respiratory organs from the dangerous effects of chemical products handled in industrial environments.

Area of Usage: Ideal for use in Aircraft, Ships, Vehicle Manufacturing, Chemical Plants, Asbestos or Mold Remediation, Assembly and Mechanical, Cleaning, Painting, Spray Coating, Spray Insulation, Industrial Construction and in every Industrial Workplace.

GENERAL FEATURES:

- ▶ Light weight & highly durable; One size fits all
- ▶ Provides high impact protection
- ▶ Comfortable & highly ergonomic in design
- ▶ Easy to assemble and dismount
- ▶ Made of an extremely soft non-allergenic Thermoplastic rubber for comfort and fit
- ▶ Hard-coated Polycarbonate scratch resistant lens
- ▶ Perfect undistorted vision
- ▶ Exhalation valve helps make breathing easier giving a cool & dry comfort to the user
- ▶ Quick Fastening Buckles which are easy to adjust and lock automatically
- ▶ Inner Mask provided with two air circulation valves for preventing the visor from steaming up
- ▶ Nape Rest for wearing mask round the neck during breaks

SIGNIFICANT FEATURES:

- ▶ The Respirator is provided with a Filter Silencer that reduces the noise to a minimum
- ▶ Equipped with an Overflow Valve which make this apparatus very comfortable to wear and use
- ▶ A System equipped with Continuous Air Flow mechanism which can easily be regulated by the user
- ▶ Conforms to EN 14594:2005 (Class 4B)

Facepiece Type: Reusable Full Facepiece

Harness Type: 5 Point

Primary Material:

Thermoplastic Elastomer for External Mask, Plain Polycarbonate lens for Visor, Head harness molded in Ethylene Propylene Diene Monomer (EPDM)



Components of KARAM Air Line System:

Full Face Mask RS 1111 : Equipped with Panoramic Visor, this mask offers superior protection with peripheral vision

Over Flow Valve RS 1201(04): Releases excess air to the external environment

Corrugated Hose RS 1201(01): Carries breathable air in the respiration zone and is positioned between the Overflow Valve and the Filter Silencer connected to the flow regulator

Belt with Flow Regulator Plate RS 1201(02): Support belt to enable easy and comfortable wearing for prolonged working hours

Flow Regulator: Equipped with quick coupling for connection to the feeding hose, it delivers a continuous flow of air that can be regulated by the user

ALSO AVAILABLE:

RS 1201 (08) : Air supply hose only (per foot)

RS 1201 (09) : Female coupling only (to connect air supply hose to flow regulator)

RS 1201 (10) : Filter silencer for Air Line System



FILTERS / CARTRIDGE

Crafted for easy installation and strong protection, KARAM brings to you a range of Filters/ Cartridges that purify airborne gas, vapours, dusts, fumes & mists.

Special Quick Connection (Snap) Cartridges /Filters: To be used with Half & Full Face Mask. Available in many versions as per the area of usage and requirement.

FEATURES:





- ▶ Consists of special Bayonet-style design for quick mounting
- ▶ Cartridges/Filters lock into its place with one twist

Threaded (Screw) Cartridges /Filters: Equipped with a screw connection according to EN 148-1, this Cartridge can be used with Full Face Mask.

FEATURES:

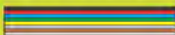
- ▶ Consists of Screw-in locking design to ensure Safety at all times
- ▶ These Cartridges/Filters are inbuilt with zero internal leakage properties

AVAILABLE IN THE FOLLOWING REF NOS. AS PER THE AREA OF APPLICATION

REF NO.	LABEL COLOUR	REF NO.	LABEL COLOUR	REF NO.	LABEL COLOUR
RS 1190(UP3)		RS 1193(A,B,E,K)		RS 1192(A,B)	
RS 1191(A ₂)		RS 1194(P,R)			

LOAD ARRESTERS



KARAM provides a vast range of Cable Load Arresters with different load capacities which are used to stop the fall of a load (basketball hoop, ramp lighting for scenic, industrial machine etc.) for a short distance in case of:

- ▶ A Break of chain or cable for hoisting the load.
- ▶ A Failure of the retaining elements of the load.

Cable Load Arresters are not PPE. They conform to Machine Directive 2006/42/CE

Dimensions (mm)



Load Arrester

Ref: LA0200-10

- ▶ Load Arrester is designed to stop the fall of a weight max 200 kg.
- ▶ Casing made up of high impact strength Polymer, to prevent breakage and is nearly indestructible.
- ▶ Galvanized Steel Wire Rope dia 4.5 mm
- ▶ Minimum breaking strength of Load Arrester Assembly > 3kN
- ▶ Minimum breaking strength of wire rope > 10kN
- ▶ Conforms to Machine Directive 2006/42/CE

Load Arrester

Ref: LA0300-10; LA0300-15

- ▶ Load Arrester is designed to stop the fall of a weight max 300 kg.
- ▶ Casing made up of high impact strength Polymer, to prevent breakage and is nearly indestructible.
- ▶ Galvanized Steel Wire Rope dia 4.5 mm
- ▶ Minimum breaking strength of Load Arrester Assembly > 4kN
- ▶ Minimum breaking strength of wire rope > 15kN
- ▶ Conforms to Machine Directive 2006/42/CE

Dimensions (mm)

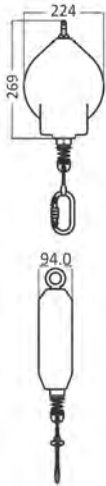

Dimensions (mm)

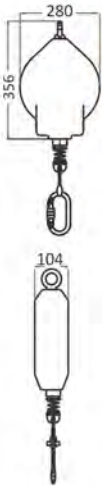

Load Arrester

Ref: LA0400-10; LA0400-15; LA0400-20

- ▶ Load Arrester is designed to stop the fall of a weight max 400 kg.
- ▶ Casing made up of high impact strength Polymer, to prevent breakage and is nearly indestructible.
- ▶ Galvanized Steel Wire Rope dia 5.8 mm
- ▶ Minimum breaking strength of Load Arrester Assembly > 6kN
- ▶ Minimum breaking strength of wire rope > 20kN
- ▶ Conforms to Machine Directive 2006/42/CE

Load Arrester

Ref: LA0500-10; LA0500-15

- ▶ Load arrester design to stop the fall of a weight max 500 kg.
- ▶ Casing made up of high impact strength Polymer, to prevent breakage and is nearly indestructible.
- ▶ Galvanized Steel Wire Rope dia 6.0mm
- ▶ Minimum breaking strength of Load Arrester Assembly > 7kN
- ▶ Minimum breaking strength of wire rope > 25kN
- ▶ Conforms to Machine Directive 2006/42/CE

Dimensions (mm)

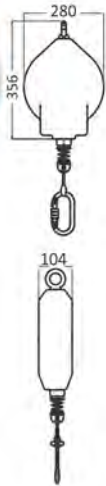

Ref.	Length	Weight	Load Capacity
LA0200-10	10 m	4.35 Kg	200Kgf
LA0300-10	10 m	5.41 Kg	300Kgf
LA0300-15	15 m	5.88 Kg	

Ref.	Length	Weight	Load Capacity
LA0400-10	10 m	11.65 Kg	
LA0400-15	15 m	12.37 Kg	400Kgf
LA0400-20	20 m	13.10 Kg	
LA0500-10	10 m	11.65 Kg	500Kgf
LA0500-15	15 m	12.37 Kg	

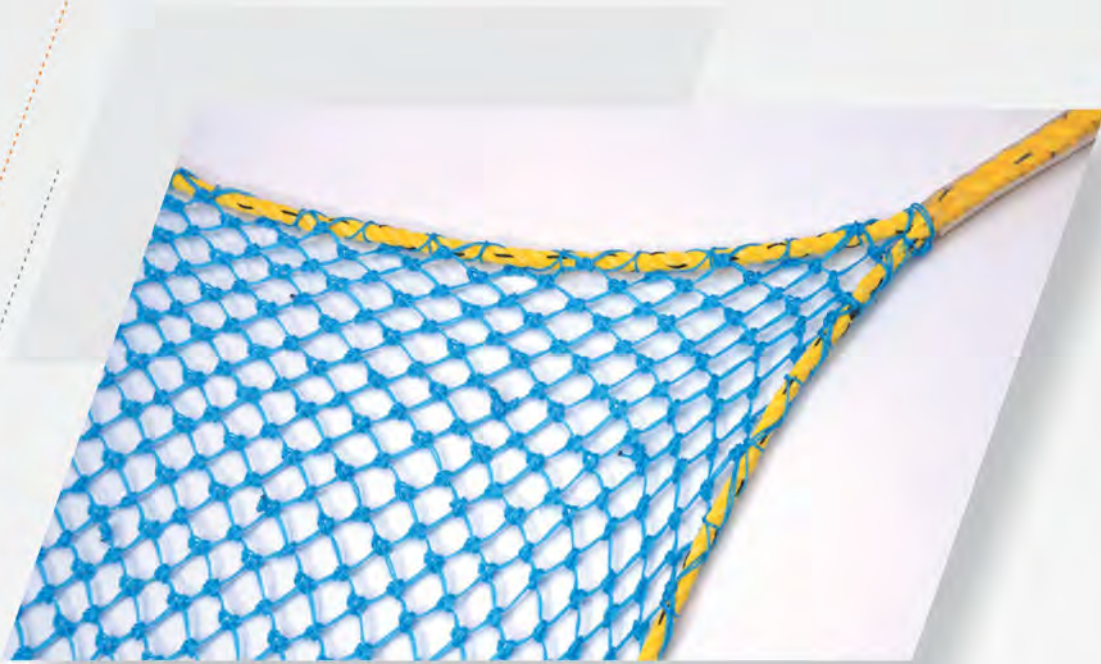

KARAM has been operating nationwide in providing the best Fall Arrest Safety Net solutions in the Construction industry, to enable the workers to work safely and effectively at heights.

The Fall Arrest Safety Nets by **KARAM** prevent fatalities and serious accidents when working at height by providing a collective level of protection.

The fundamental principle governing the design and performance of **KARAM** Safety Nets are as follows-

- Made from high strength Polypropylene Ropes which are able to withstand the required load.
- Special Knotting of the meshes work towards effective Shock Absorption, hence minimizing any impact related injury on to the worker.

KARAM Fall Arrest Safety Nets are available in various sizes, as required. Some of the standard sizes are available as below-

Safety Net Size	Mesh Size	Mesh rope	Additional
10 m x 5 m	25 mm	2 mm Double Cord	-
10 m x 5 m	100 mm	4 mm	-
10 m x 5 m	100 mm	4 mm	With Overlay Net
6 m x 4 m	25 mm	2 mm Double Cord	-
6 m x 4 m	100 mm	4 mm	-
6 m x 4 m	100 mm	4 mm	With Overlay Net



BRINGS TO YOU



PPE INSPECTION

PERSONAL PROTECTIVE EQUIPMENT

ON YOUR SITE



Activities at height are inherently dangerous and may lead to severe injury or even death. Proper usage of PPE can hence play the most vital part in ensuring safety in such conditions. It therefore becomes mandatory to inspect PPE before each use.

Improper storage and sometimes misuse of these products may contribute to their safety performance.

Hence a regular, proper and systematic inspection carried out by trained personnel ensures that only the right equipment is put to use each time.

KARAM has formulated a highly systematic approach for the **Inspection of PPE**.

KARAM PPE INSPECTION enables timely detection of any kind of compromise on performance in the equipment which could lead to a dangerous situation, if unheeded.

All the procedures for Inspection are performed by authorized Inspectors trained by **KARAM**

SIGNIFICANT FEATURES

INSPECTORS

Trained and Competent Personnel.

Refresh Training for Inspectors - done on a scheduled and regular basis.

Unique Inspector Identification Code is allotted to each Inspector for complete traceability.

INSPECTION PROCEDURES

Well documented processes for detailed visual inspection.

Identified bays for 'Accepted' & 'Rejected' materials.

Proper "Inspection Checked OK" tagging on all Accepted products.

TEST REPORTS & CERTIFICATION

Detailed Test Reports for each product tested.

PPE Inspection Certificate provided after each Testing Schedule.

LABORATORY TESTING

Availability of Laboratory Strength Test through defined sampling procedures.

Detailed Test Reports with findings provided on request.

All Tests carried out in KARAM Testing Laboratory (in process for accreditation by SATRA, UK).



Register with KARAM for the Inspection of PPE and ensure complete Protection from Head to Toe.

For further details, kindly contact at customercare@karam.in



DISPOSAL METHODS FOR KARAM PRODUCTS



Steps to follow for disposal of Harnesses:

1. Open up the Harness which has to be discarded completely from all of its buckles and loops.
2. With the help of a pair of Scissors cut out all the metallic components from the harness, and collect them in a container. These metallic components are buckles, frames, D-rings, and metallic loops.
3. Separate out the webbing, pads and the loops from the Harness. These constitute the Non-Biodegradable Polymers of the product, and should be disposed off as mentioned in the section below.

Steps to follow for disposal of Helmets:

1. Remove the Cradle and Shell-Harness from the Shell of the broken/ damaged helmet.
2. Place all the parts into a single container, and this waste should now be disposed off as the other Non-Biodegradable Polymers.



Disposal of the Non-Biodegradable Components:

It is important to place these waste components into specially designated covered containers, and proceed to dispose them as per the Regulations of Disposal of Plastic materials, or as follows:

Send the waste to Personnel who Re-cycle the material (Junk-yard or Scrap operators, or 'Kabadis')

Send the waste to Plastic Disposal Grounds which have special equipment and machinery to execute safe disposal.

Precautions to be taken while disposing off the Polymer waste:

1. Do not mix with Bio-degradable forms of waste, like paper, cotton wastes, etc.
2. Do not burn the waste because this will create toxic fumes and shall pollute the air.
3. Keep the waste in covered containers away from potential fire hazard, since the polymer waste can easily and quickly catch fire.
4. Refrain from dumping.

Disposal of the Metallic Components:

These metal parts should be put in suitable Containers and can be disposed off as Scrap, where it shall reach suitable Re-cycling Plants for further use.

Precautions to be taken while disposing off the Metallic waste:

1. Do not mix with Bio-degradable forms of waste, like paper, cotton wastes, etc.
2. Handling of Metallic wastes should be done using proper PPE, to avoid injury from sharp edges, or metallic dust particles.
3. Refrain from dumping.



Warning:

Most synthetic polymers are non-biodegradable; it is preferred that they be put to re-cycle since safe methods of their disposal are still under the preview of Environmental and Bio-technological Scientists, world-wide. Recycling of Plastics shall be undertaken strictly in accordance with the specifications laid by the Bureau of Indian Standards.

Disclaimer: KARAM believes the information herein to be accurate and reliable as far as is possible. However since any advice furnished by KARAM with reference to disposal is provided without charge, and since such matters are not within its' control, KARAM assumes no obligation or liability for such advice. Information herein contains safety issues relating to the disposal of Full Body harnesses and helmets and is not to be used as a guide to compliance with national or state laws and regulations. Since governmental regulations may differ from one location to another and may change with time, it is the responsibility of each company to ensure their workplace and disposal practices are in compliance with all laws, regulations, ordinances and other governmental enactments applicable in the jurisdiction(s) having authority

EXCELLENCE THROUGH TRAINING



KTC's UNIQUE EDGE

- ▶ Manufacturing expertise and usage experience in Fall Protection Equipment for last 19 years.
- ▶ In-depth understanding of EN norms.
- ▶ Familiarity with hazards and risks prevalent in industries such as Construction, Telecom, Cement, Refineries, Power Transmission, Manufacturing and Steel.
- ▶ Customised trainings as per client requirements.
- ▶ Faculty comprises of experienced industry professionals.

KTC AIMS TO

- Create Safety Awareness
- Create Work at Height (WAH) competency
- Impart Technical Knowledge on WAH
- Impart Product Knowledge



KTC OFFERS PROGRAMS ON

Working At Height (WAH) Competency

Level-II : Advanced Training for Managers & Supervisors

Level-I : Basic Training for Workers

Working At Height for Telecom Industry

ATHR : Advanced Training on Height and Rescue

CBTHR : Contractor Training on Height and Rescue

Working at Height (WAH) Awareness

Confined Space Entry

Rescue

Level-II : Advanced Training for Designated Rescuers

Level-I : Basic Training for General Workers

Industry specific

- ▶ Construction Safety
- ▶ Scaffold Safety
- ▶ Electrical Safety
- ▶ Lock Out Tag Out (LOTO)

General

- ▶ Hazard Identification & Risk Assessment (HIRA)
- ▶ PPE Introduction & Inspection Training
- ▶ Site inspection & Safety Audit

Customised Training Programs

KTC's TRAINING FACILITIES

- ▶ Specially built 10m Training Tower for WAH Simulation
- ▶ Mock Confined Space Training area
- ▶ Specially built Anchorages
- ▶ Fixed Line Systems installations
- ▶ Fully equipped Training Halls



For more details, write to ktc@karam.in



KARAM® introduces

first
time in
INDIA

Quality Service Solutions

for
*Retractable Fall
Arrester Blocks*



Quality
Service
Solutions



KASC
KARAM AUTHORISED SERVICE CENTER

KASC is a **UNIQUE INITIATIVE** by KARAM to Provide **Servicing** and **Repair** of KARAM **RETRACTABLE FALL ARRESTER BLOCKS** being used in Various Industries.

To know more write to us at service@karam.in or visit us at www.karam.in

head protection

safety spectacles

ear protection

welding protection

respiratory protection

fall protection

rope access & rescue

confined space entry

foot protection

fixed fire systems

training

servicing

REGIONAL OFFICES

- Bangalore : Shop No.20/21, Ground Floor, SPA Plaza, OTC Road, Bangalore-560 002.
Phone: +91 80 41661080 / 90, Fax: +91 80 22220030, e-mail: bangalore@karam.in
- Delhi NCR : D-95, Sector - 2, Noida-201301 Delhi NCR, India.
Phone: +91 120 4734400, Fax: +91 120 2541096, e-mail: delhi@karam.in
- Kolkata : Flat No.: L, 6th Floor, Block- I & II Diamond Chamber 4, Chowringhee Lane, Kolkata-700016.
Phone: +91 33 32476830, Fax: +91 33 22520181, e-mail: kolkata@karam.in
- Mumbai : The Affaires, Office No. 501, Plot No. 9, Sector-17, Palm Beach Road, Sanpada, Navi Mumbai-400705.
Phone: +91 22 27812390 / 64, Fax: +91 22 27812358, e-mail: mumbai@karam.in

BRANCH OFFICES

- Ahmedabad : 206-Matrix, Near Divya Bhaskar Press, SG highway, Ahmedabad-380054.
Phone: +91 792 9702420, Fax: +91 79 29702420, e-mail: riteshp@karam.in
- Chennai : Door No. 22 A, Venkatesa Thyagaraja Nagar, Off 100 Ft Road, Backside of Raghavendra IOCL Petrol Pump, Villivakkam, Chennai-600049.
Phone: +91 44 26502675 / 76, e-mail: chennai@karam.in
- Hyderabad : 5-5-51/1, 2nd Floor, SL Complex, Ranigunj, Secunderabad-500003.
Phone: +91 40 27807674 / 75, Fax: +91 40 40170485, e-mail: hyderabad@karam.in

VIRTUAL OFFICES

- Ambala : Mob.: +91 98738 52197, e-mail: sushilkumar@karam.in
- Cochin : Mob.: +91 99953 44411, e-mail: mohandasan@karam.in
- Coimbatore : Mob.: +91 96777 23240, e-mail: bagyarajk@karam.in
- Cuttack : Mob.: +91 99370 28460, e-mail: ranjan@karam.in
- Guwahati : Mob.: +91 88110 86929, e-mail: tamal@karam.in
- Jabalpur : Mob.: +91 99814 54646, e-mail: mukeshmishra@karam.in
- Jamshedpur : Mob.: +91 97714 93595, e-mail: shekharkumar@karam.in
- Singrauli : Mob.: +91 74897 39390, e-mail: abhaykumar@karam.in
- Lucknow : Mob.: +91 96702 44833, e-mail: aditya@karam.in
- Visakhapatnam : Mob.: +91 98853 68386, e-mail: srikanthpotnuru@karam.in

VERTICAL OFFICES

- Fixed Line System : Mob.: +91 98999 75687, e-mail: fls@karam.in
- KARAM Authorised Service Centre : Mob: +91 99907 83636, e-mail: service@karam.in
- KARAM Training Center : Mob.: +91 93120 03748, e-mail: ktc@karam.in
- Customer Care Department : Phone: +91 120 4734400, e-mail: customercare@karam.in

CORPORATE OFFICE

D-95, Sector 2, Noida-201301 (UP) Delhi NCR, India. Phone: +91 120 4734400, Fax: +91 120 2541095, e-mail: karam@karam.in

Toll Free Number: 1800 103 7085